

PS266

USER'S MANUAL



peecker sound®

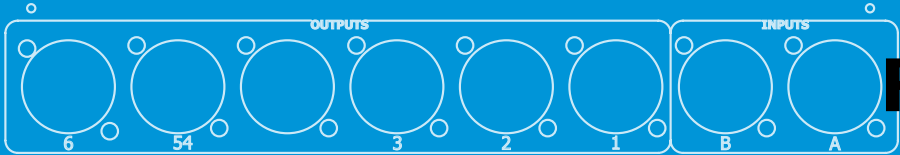
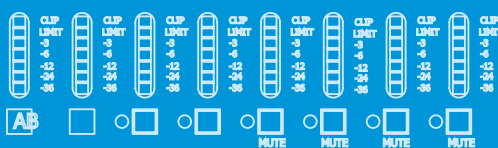

TABLE OF CONTENTS

TABLE OF CONTENTS	
1. IMPORTANT SAFETY INSTRUCTIONS	pag. 3
2. DECLARATION OF CONFORMITY	pag. 3
3. WARRANTY	pag. 3
4. USER LIABILITY	pag. 4
4.1 Dangerous output voltage 4.2 Radio interferences	
5. INTRODUCTION	pag. 4
5.1 Unpacking 5.2 Installation 5.3 Key features 5.4 Front panel 5.5 Rear panel	
6. OPERATING INSTRUCTIONS	pag. 6
6.1 Connection to the AC mains supply and power absorption 6.2 Connection to an external PC 6.3 Graphic Interface Description	
7. BASIC OPERATIONS AND SYSTEM UTILITIES	pag. 9
7.1 Power 7.2 Programs 7.3 Configurations 7.4 Stereo link 7.5 Crossover mode 7.6 Delay units 7.7 Protection 7.8 Contrast 7.9 MIDI operation	
8. DSP FEATURES	pag. 14
8.1 Input channels 8.2 Output channels 8.3 Equalization	
9. TECHNICAL SPECIFICATIONS	pag. 18



1. IMPORTANT SAFETY INSTRUCTIONS



This symbol indicates *key operating instructions and information* requiring particular attention for correct use of the product.



This symbol warns of *dangerous voltage* and the consequent risk of electric shock. Take extra care and proceed with caution.

1. Read carefully all the attached product documentation and keep for further reference.
2. Heed the warnings.
3. Keep the packaging and check that all the material is in perfect condition.
4. Do not use the product in the vicinity of water or pour water or any other liquid on the controller. Take care not to use it with wet hands or with your feet in water.
5. Do not use near sources of heat such as radiators, stoves or other heat-producing appliances.
6. Check that the power cable is intact and undamaged. Do not tread on the cable and take care not to put any pressure on the plug.
7. Connect the plug to a properly earthed electric socket. Do not tamper with the plug. Should the plug supplied not fit your socket, have an electrician replace it with the correct one.
8. Connect to the mains supply having identical voltage as that indicated on the back of the controller.
9. Install the controller in compliance with the instructions.
10. Do not obstruct the air ducts.
11. Disconnect the appliance in case of storms or when not in use.
12. Wire exclusively as shown in the instructions.
13. Do not remove the upper or lower covers as this would expose the user to the risk of electric shock.



14. Do not attempt to repair the appliance yourself but always seek the assistance of qualified technicians.
15. Do not connect an input signal higher than that indicated in the manual.
16. Clean with a dry cloth only.
17. The product must be handled by qualified technicians when:
 - the power cable or the plug is damaged
 - the product has been exposed to rain or humidity
 - liquid has got inside the unit
 - an object has fallen on the unit
 - the unit has fallen and is damaged
 - the appliance seems to be malfunctioning or is showing a marked change in performance
18. Careful supervision is required if the product is used in the presence of children or by unskilled adults.
19. This appliance may produce sound pressure levels damaging to the hearing. Take the utmost care and do not use the product for long periods of time at high levels or at uncomfortable volume levels. Should you experience any hearing loss or buzzing in your ears, consult an audiometric specialist.

2. DECLARATION OF CONFORMITY

This device complies with the requirements of the *European Electromagnetic Compatibility Directive* 89/336/EEC (and relevant 92/31/EEC amendment) as well as the requirements of the *Low Voltage Directive* 72/23/EEC (and relevant 93/68/EE amendment).

Regulations applied:
EN55103-1 (*Emissions*)
EN55103-2 (*Immunity*)
EN60065, Class I (*Safety*).



3. WARRANTY

Peecker Sound products are guaranteed against malfunction due to defective materials or workmanship for a specified period of time, starting from the date of original purchase. Should a malfunction occur during the warranty period, the product will be repaired or replaced (at the manufacturer's discretion) free of charge. The shipping costs and related risks, and any loss during shipment to authorized service centres are the responsibility of the customer. The product will be returned to the customer with a carriage forward shipment.

Warranty terms

The warranty covers the appliance under its initial purchase in compliance with the laws in force. The warranty is valid for *3 years*, starting from the date of receipt of the product. Peecker Sound reserves the right, in certain cases, to decide to replace the appliance with another identical or similar product. The warranty is not extended following a product failure. The warranty does not cover any incidental or consequential damages, without limitation, caused to persons or property during any period of inefficiency of the appliance.

Exclusions and limitations

The warranty does not apply to:

- any damage to exterior finishings or surfaces, aesthetic elements, or electric/electronic parts resulting from negligent use of the product;
- malfunction resulting from incorrect or improper use of the product or from transport without due care;
- malfunction resulting from repairs carried out by unauthorized persons or service centres;
- malfunction due to circumstances that cannot be ascribed to manufacturing defects of the appliance;
- plastic or glass parts, bulbs and the like, as well as all that can be regarded as normal wear and tear. As regards circuit components (transistors, diodes, etc.) the general terms set by the original manufacturers apply.

The following are also not covered by the warranty:

- damage caused by accidents, product modifications, negligence or incorrect connection
- damage that occurred during transport
- damage resulting from failure to comply with the instructions contained in the user's manual
- claims based on misrepresentations by the seller and any product whose serial number has been rubbed off, modified or removed.

Receiving warranty service

To receive repair or replacement of the product under warranty, the customer must deliver the product in its original packaging carriage paid to an authorized Peecker Sound service centre together with the relevant proof of purchase, i.e. bill of sale, receipt or invoice.

The warranty service and list of authorized service centres is available at the address below:

Peecker Sound - "After Sales Service"

Via Monti Urali, 29 - 42100 Reggio Emilia (Italy)
Tel: +39 0522 557735 - Fax: +39 0522 391268
E-mail: info@peeckersound.com

Repair or replacement of the product and its return to the customer are the only services provided to the customer. Peecker Sound shall not be held liable to pay incidental or consequential damages including, without limitation, injury to persons or property or loss of use.

Costs paid by Peecker Sound

Peecker Sound will pay for all labour and material expenses necessary for the repairs covered by the warranty. Make sure you keep the original packaging; otherwise, the cost of replacing will be charged to you if necessary. Produce the original invoice to establish the date of purchase.

Do not send the product to the factory without prior authorization. Should shipment of the product be a problem, please contact the service centre, who will deal with it promptly. Otherwise, the customer is responsible for shipment and handling of the product to be repaired and payment of all shipping costs.

Limitation of implicit warranties

All implicit warranties, including guarantee of merchantability and suitability to specific purposes, are limited to the duration of the present warranty. With the exception of certain types of damage, Peecker Sound liability is limited to repairing or replacing, at its discretion, any defective products, with no obligation of compensation for any kind of incidental or consequential damages. In case of any controversy, the court of jurisdiction will be exclusively the Court of Reggio Emilia (RE) – Italy.

4. USER LIABILITY

4.1 Dangerous output voltage



Do not touch exposed cables while the processor is operating.

4.2 Radio interferences

A sample of this product has been tested and approved in compliance with the limits set out by the Electromagnetic Compatibility Directive (EMC). These limits have been determined in order to provide reasonable protection from dangerous interferences caused by electrical appliances.

Should this product not be installed or used in compliance with the instructions as set out in this manual, it might interfere with other appliances such as radio receivers, for example. There is no guarantee, however, that interferences will not occur in a particular installation.



Should the device interfere with two-way radios (switching the device on and off will allow you to check whether this is the case), you should try to eliminate the interference by adopting one of the following measures:

- Increase the distance between the appliance and the receiver.
- Connect the appliance to a socket positioned on a circuit different from which the receiver is connected to.
- Re-position or move the aerial of the receiver.

Check that the unit complies with the EMC immunity limits (it must carry the CE mark). All electrical appliances sold in the EU must be approved for immunity to electromagnetic fields, high voltage and radio interferences. Seek professional assistance.

5. INTRODUCTION

Congratulations on your choice of the Peecker Sound **Digital Speaker Management System PS266** and thank you for your confidence in us and our products. Your controller has been carefully engineered down to the smallest detail, from component selection to final assembly. All Peecker Sound products aim for full customer satisfaction and you can rest assured that the product you have chosen uses cutting-edge technology.

The controller has been designed in the Sound Corporation Design and Research&Development (R&D) departments paying particular attention to the choice of materials, safety devices and electronic design for the manufacture of a safe, reliable and long-lasting product. Since inappropriate use of the product can jeopardize its correct operating performance, please ensure that you use it carefully and correctly. Please read this manual carefully: all the information it contains is vitally important for using your appliance safely.

5.1 Unpacking

Inspect the packaging and its contents immediately to check whether there are any signs of damage. After unpacking, inspect the product and any accessories. Should you notice any damage, inform your dealer immediately.

Please keep all the packaging materials, which will be useful for returning the product to Peecker Sound or sending it to one of our authorized Service Centres if the product does not arrive in perfect condition. Use exclusively the original packaging, as it is the best way to protect the appliance from mishandling by the carrier.



Please take care of the environment. Once the appliance has become obsolete, please dispose of it in the appropriate recycling container.

5.2 Installation

The Peecker Sound PS266 processor may be installed in standard 19" racks. There are four installation holes on the front panel for optimal securing of the appliance – an important factor in mobile systems.

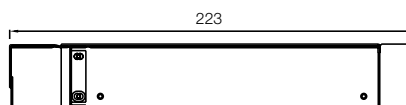
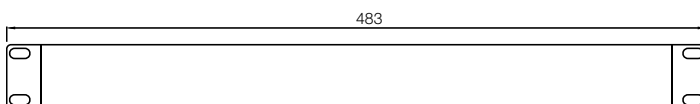

Figure 1. PS266 dimensions



When moving the equipment with a trolley take extra care not to injure yourself.

Please remember that the controller should not be installed in venues with:

- High temperatures
- Dust and excessive humidity
- Intense magnetic fields
- Water in the vicinity of the unit
- Vibrations
- Enclosed spaces that inhibit proper ventilation

5.3 Key features

- Active crossover filters with up to 48 dB/octave slope
- 2 inputs, 6 outputs
- Max 12 bands for *parametric* or *shelving* equalization per channel
- 60 memory locations for User Programs
- Up to 635 ms input and output signal delay (in 21µs steps)
- Output limiters with adjustable thresholds and attack and release settings based on cut-off/crossover frequency
- Front panel controls for muting functions, programming and level settings
- Security Lock Out modes for protecting setting programs
- Polarity reversal switch on each output
- Digital gain adjustment from -15 dB to 15 dB
- MIDI (sysex) dump system to save and transfer data
- Program compatibility between different units and setting storage capability

5.4 Front panel

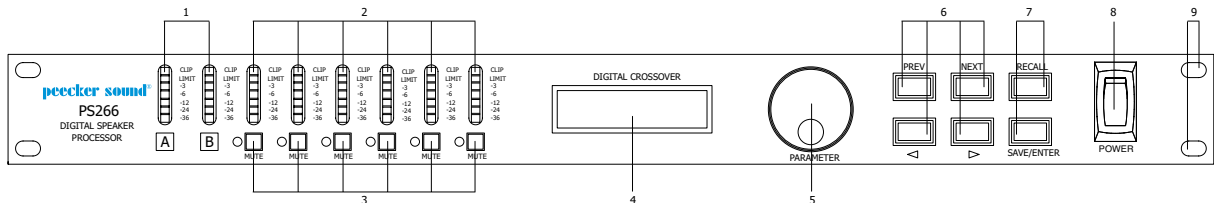

Figure 2. PS266 Front panel

1) LED input bar graphs

The LED input bar graphs show the level of input signal, respond to inputs from -30 dB to -3 dB and indicate the input signal clipping. The following signal levels are displayed: -30 dB, -24 dB, -6 dB, -3 dB, LIMIT, CLIP.

2) Output LED bar graphs

The output LED bar graphs indicate the output signal level in relation to the limiter threshold. The following signal levels are displayed: -30 dB, -24 dB, -6 dB, -3 dB, LIMIT, CLIP.

3) MUTE

The indicators next to the MUTE buttons show their current status. Press these buttons to switch the mute function ON>OFF and vice-versa.

4) Display (2x16 character LCD)

The LCD display shows information on the selected parameters. The bottom line of the default screen appearing after start-up shows the number and name of the last program saved. The memory of the unit will always contain at least one allocated program if nothing is specified in the bottom section.

5) Rotary encoder

A continuous rotary encoder is located to the right of the display screen. It allows the scrolling and selection of the menu parameters and it can also modify the parameter values.

6) PREV, NEXT, ◀, ▶

These buttons allow access to the various screens and selection of the parameter to be adjusted (PREV / NEXT) as well as the value of the selected parameter (◀, ▶). Should the parameter not be numerical, these buttons can be used to scroll through the list of options.

7) RECALL, SAVE/ENTER

Use these buttons to save the programs in a new memory location and to recall settings saved in internal memories.

To load a previously memorized program, press the RECALL button on the front panel. To select the required program, use the PREV/NEXT buttons to the right of the LCD screen, then press RECALL again to call up the program. To save a program in a particular memory location, press SAVE, select the memory location where you wish to save the program and enter the program name.

You can also use the SAVE button as an ENTER key to confirm certain operations. Pressing the SAVE key when in RECALL mode will exit the operation.

8) POWER

On/Off switch

9) Installation holes

5.5 Rear Panel

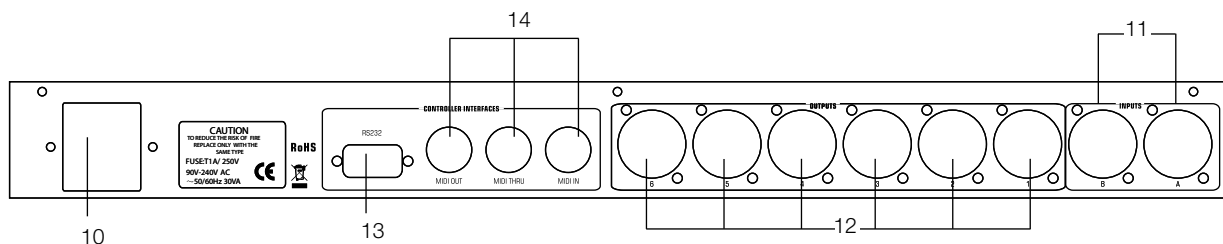

Figure 3. PS266 Rear panel

10) AC Power socket

The processor has a power supply operating capability ranging from 90 V to 250 V, at 50/60 Hz, with automatic adjustment to the input voltage.

11) Audio Input connectors

The audio input connections are made using electronically balanced Cannon® XLR connectors. The two inputs provide the input for the DSP chain.

12) Audio Output connectors

The audio output connections are made using electronically balanced Cannon® XLR connectors. The six outputs provide the direct output to other devices.

13) Communication port connectors

The PS266 processor can be entirely controlled via a PC through the *Digital Speaker* software.

The connection is normally made via the serial port connector (RS232). This port is also used to upgrade the firmware.

14) MIDI OUT, MIDI THRU, MIDI IN connectors

The three MIDI connectors are required for transmitting and receiving Program changes and for transmitting the system exclusive dump data between the different units.

6. OPERATING INSTRUCTIONS

6.1 Connection to the AC mains supply and power absorption



Check that your mains power supply is sufficient for the power requirement of your controller.
The voltage of the electric mains must correspond to the voltage indicated on the back of the processor. Maximum current absorption is limited by internal fuses.

6.2 Connection to an external PC

The *Digital Speaker* software allows the user to create, modify and cancel audio configurations (*presets*) inside the PS266 processor through a user friendly interface from PC, in a visual and consequently easier way.

The connection between the PC and the processor occurs through an RS232 (serial) port and a proprietary protocol.

The connection of PS266 processor to the PC occurs through an RS232 (serial) interface by a cable with DB-9 male → female DB-9 connector.

The installation CD, included to each digital processor PS266, is necessary to install the software.

Note: if a RS232 serial port is missing in the PC, it will be possible to use an USB-RS232 adapter, available on sale. In this case, after the driver installation, a virtual serial (COM) interface is created, to be selected on *Config* → *RS232* menu before using the software.

Serial (COM) port must be included between COM1 and COM4.

If virtual serial port is not included between them, please refer to adapter manual or operating system manual, for the modification process.

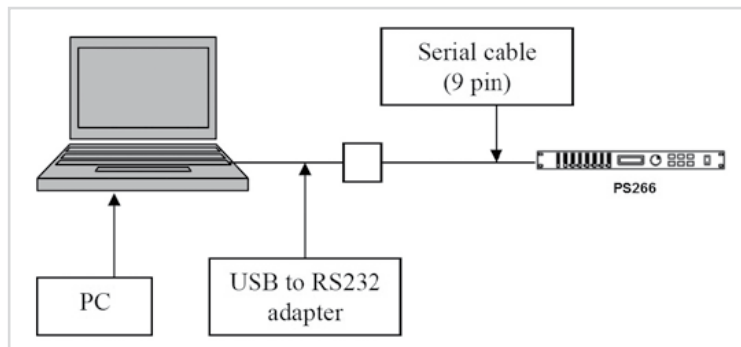

Figure 4. PC - PS266 connection scheme

Content

Each CD contains the files necessary to the software installation.

System Least Requirements

- IBM compatible PC
- Pentium I 133 Mhz
- 64 MB RAM
- 500 MB available on hard disk
- VGA graphic card
- Serial port
- Mouse
- Microsoft Windows XP, Vista, WIN 7 (or previous versions)

Installation

Software installation occurs as usual in Windows systems.

1. Insert the program CD
2. Double-click on the *PS266_V2.30.exe* icon (or the next ones)



3. Follow the instruction of the user friendly and intuitive installation program.
Attention: before proceeding with the connection of the processor to the PC (and before triggering the Digital Speaker program), it is necessary to configure the processor to the **MIDI MODE PCPort** and **MIDI Channel 1**.

To do it, use the PREV/NEXT keys by scrolling the SET UP menu and set the field as indicated, by using the rotative encoder.

Once the processor has been set so, trigger the Digital Speaker program and connect to the processor by clicking on the fourth icon in the Toolbar.

If the processor has not been indicated, the following error message will appear, by clicking on the "arrow" icon.

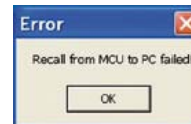

6.3 Graphic Interface Description

• Menu



The Menu bar includes the following items (from left to right):

1. *File*: it allows to exit from the program (*Exit*);
2. *Config*: it allows to manage the several functions of the software. The items of the drop down menu are as follows:
 - 2.1 *Figuration*: it manages the configurations of the processor

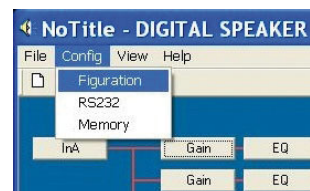

They can be:

- *Mono*: 1 input and 6 outputs
- *2 Channel - 3 Way*: 2 inputs (Left and Right) and 3 outputs per channel
- *3 Channel - 2 Way*: 2 inputs (Left and Right), 2 stereo outputs per channel plus 2 mono outputs (Sum A+B).

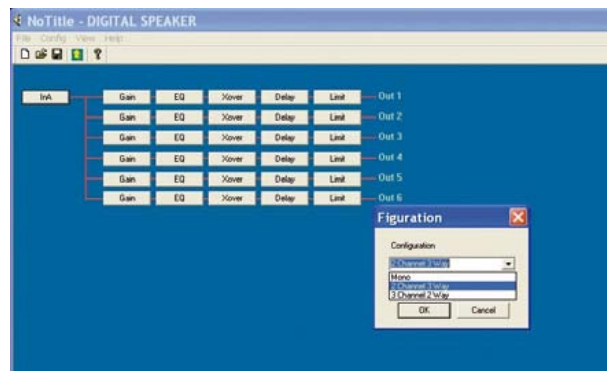

2.2 *RS232*: it allows to choose the link port to the processor.
Select the RS232 (COM) port, in case it does not occur automatically.

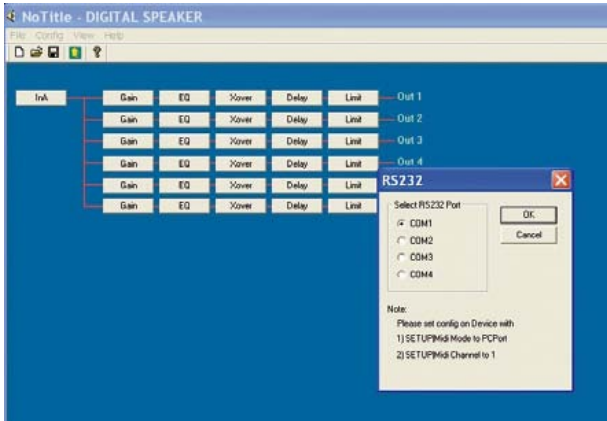

2.3 *Memory*: it manages the **EEPROM** memory of the processor.
Click the Memory key to enter the programs saved in PS266 (60 available presets).

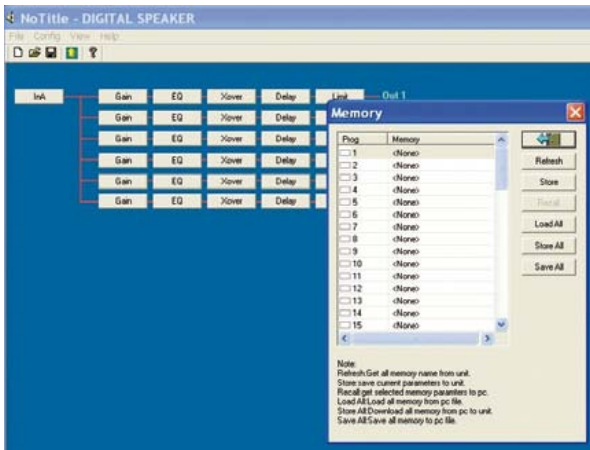

Buttons on the right allow the following operations:

- 2.3.1 *Refresh*: it makes visualize the presets currently memorized on the device
- 2.3.2 *Store*: it saves the current preset in the PS266 inside memory
- 2.3.3 *Recall*: it recalls the preset from the PS266 inside memory
- 2.3.4 *Load All*: it loads all the presets included in the PC (files .ay)
- 2.3.5 *Store All*: it stores (by overwriting) the list imported by Load All
- 2.3.6 *Save All*: it saves all the presets stored in the PC (files .ay)

3. *View*: it allows to choose what to view in the graphic interface;

4. *Help*: user's guide.

• Toolbar

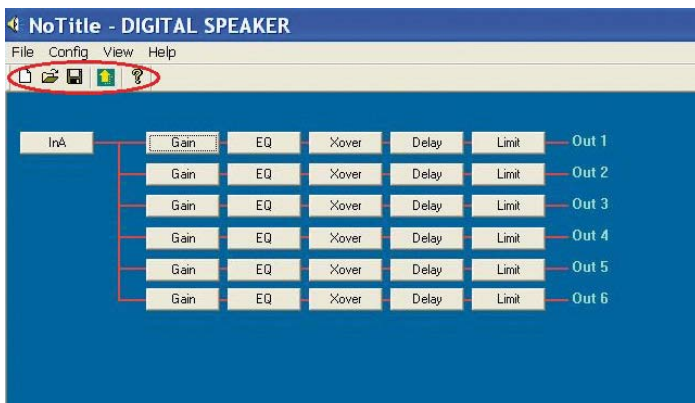

The toolbar allows a quick access to the following functions (from left to right):

- A new preset creation;
- Opening of an existing preset;
- **Overwriting of the current preset or Save As, if recalled from Memory;**
- Upload key;
- View of the credit window.

• Configuration Area

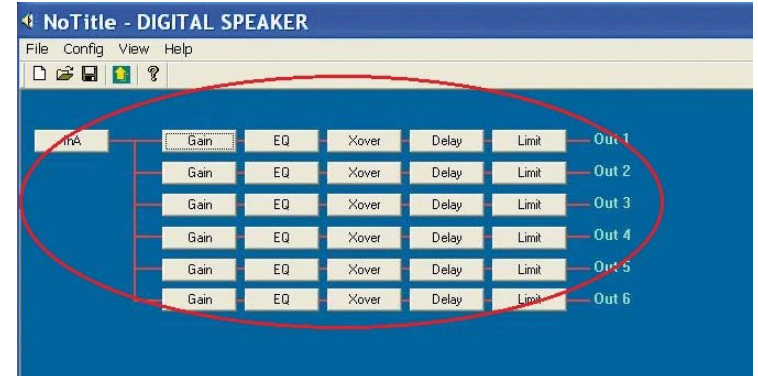

The structure of the configuration area depends on the layouts of the *Figuration* menu, because it shows the path of the signal from the input to the processor to the output. In the case named, there are only 1 input and 6 outputs (*Mono* configuration).

A click in the area indicated in the red circle causes the opening of a window that includes all the controls in the block diagram.

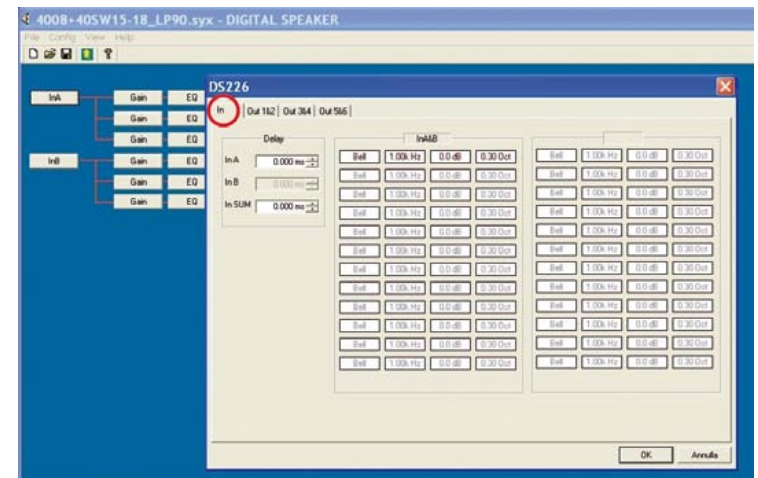

• Description of the Control Window

The first folder in the top left-hand corner of the window (*In* folder) allows to enter the controls of the **equalization** and of the **input delay**. They are useful to apply modifications to the sound configurations (according to the surrounding, the installation type, etc.) without acting on the factory output presets.

Clicking on the red record it is possible to enter the setting in detail of the EQ input (type of filter, frequency, gain, etc.).

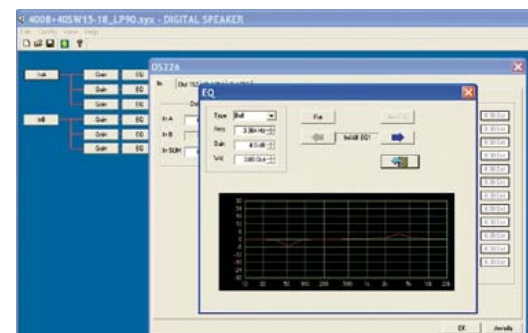

Clicking on the other folders in the same window, it is possible to **configure outputs** without coming back to the general configuration display.

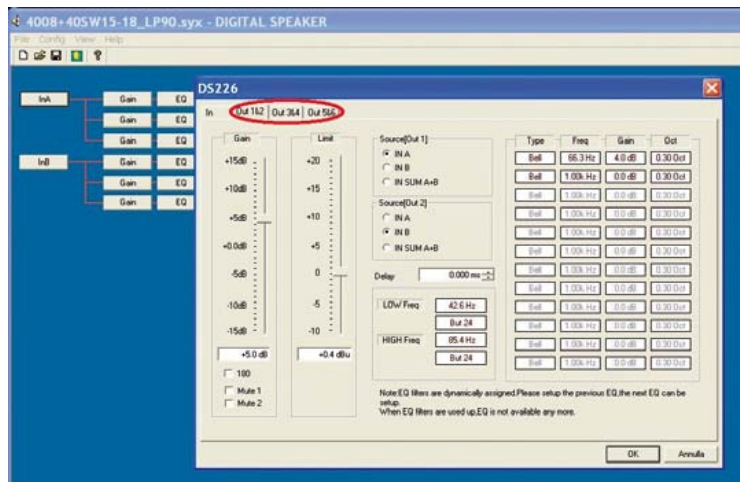

Each output channel includes the layout to set the following parameters:

1) Output gain for the channel (*Gain*)

The output gain layout for this channel is made by running the cursor to the top or to the bottom, the selected value is shown in the text box under the cursor.

2) Output limiter for the channel (*Limit*)

The layout of the limiter for this channel is made by running the cursor to the top or to the bottom, the value selected is shown in the text box under the cursor.

3) Mute function (*Mute 1, Mute 2, etc.*)

4) Phase inversion (*180*)

5) Source layout for the channel (*Source*)

The source of the selected channel allows to choose if that channel must receive the signal from the right channel, from the left channel, or the sum of both of them (SUM A+B). This function is user friendly, if the processor is used in stereo, but subwoofers must be in mono.

6) Output delay for channel (*Delay*)

The layout of the output delay for the selected channel is made by inserting the value by hand in the text box or by using the arrows on the side of the box to the value requested.

7) Crossover cut (*LOW Freq, HIGH Freq*)

The cuts made by the crossover are selectable through the controls respectively referring to pass-high and pass-bass filter. "OUT" wording in place of frequency (in the top windows) is for the non-intervention of the crossover for that filter.

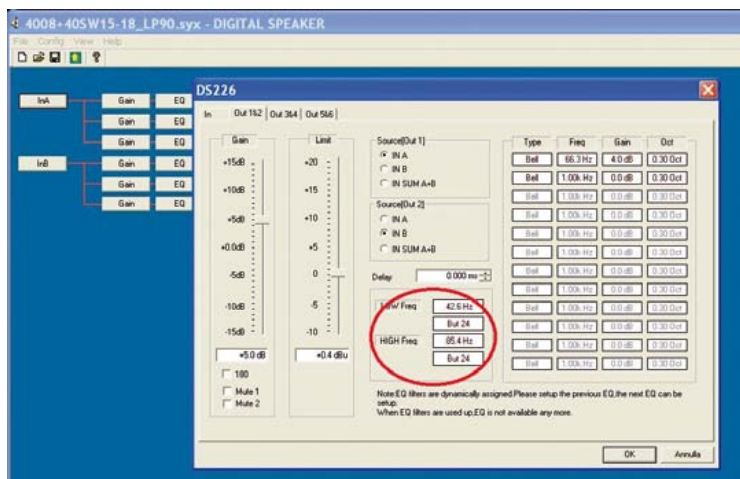

8) Output parametric equalization

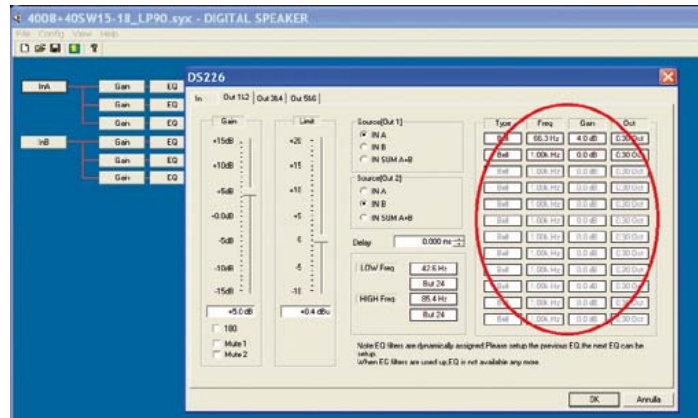

Clicking on the controls of the parametric equalizer it is possible to modify its values through a second window. This window includes 4 text controls and 2 buttons with the following functions:

Type: type of equalization filter

Note: the Shelving type of filter ("Low/High 6" or "Low/High 12"), unlike Bell that has a certain central frequency, optimally works from a certain frequency to the device upper limit.

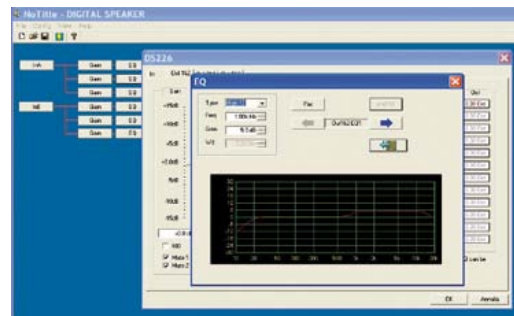

Freq: Equalization frequency

Gain: height of the curve of equalization

Wd: width of the curve of equalization, set into octaves

Flat: reset of the equalization band to the default layouts

Add EQ: it allows to add a further equalization.

Attention: the processor has a maximum of 18 calculation slots. Each equalization band and each 24 dB of crossover cut engage 1 of them, therefore, if all 12 equalization bands are used for one channel, there will be no other available for the other channels, nor crossover cuts.

• Recall and Save of an Audio (preset)

To recall/load a preset:

a) **from PS266 to PC**: in the *Config* -> *Memory* sub-menu, the *Refresh* key allows to view the list of 60 presets available in the EEPROM of PS266.

To recall one of them, select it and then click on *Recall*;

b) **from PC to PS266**: it is just necessary to import the preset (file with .sys extension downloadable straight from the Peecker Sound website) using the folder icon in the toolbar (the second one from the left) or straight double-clicking on the .sys file on desktop.

To save a preset (new or a modification of a loaded one):

a) **on EEPROM of PS266**: it is enough to enter in the *Memory* menu, after fixing the sound configuration required, save the preset in the program number (60 available) and click on the *Store* button (the software will ask to name the preset).

Note: after closing the window, the program will ask to save (or not) on the PC the .sys file imported or to generate a *NoTitle.sys* file;

b) **on PC**: use the floppy disk icon (third one from left in the toolbar) from the EEPROM memory of PS266 (a file with .sys extension is saved on the PC), but ONLY after recalling the preset previously saved according to the item a).

Attention: in fact, the floppy icon of the toolbar works as *Save As* (not as *Save*, that would overwrite the modifications on the current preset) ONLY after recalling the configuration from the memory of the processor. Therefore, it is suggested to save on this EEPROM every modifications to a preset imported.

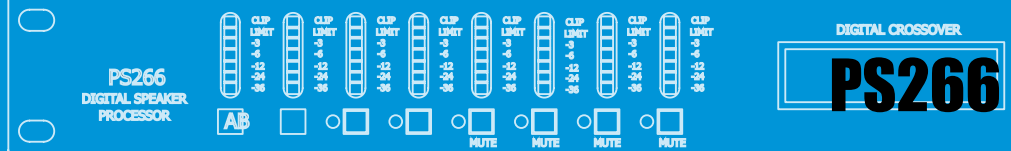

7. BASIC OPERATIONS AND SYSTEM UTILITIES

7.1 Power

After duly connecting the processor to the mains power supply, turn on the unit by pressing the switch located on the front panel. During the switch-on process, the name and model number of the firmware application will appear on the LCD display and the outputs will be on *mute* until the unit's internal checks have been completed. Once the start-up routine has been completed, the unit will be ready for the audio signal processing. The DSP will be automatically reconfigured with the settings of the last working session.

7.2 Programs

• Program saving

A program can be saved in any one of the **60 available memory addresses**. On pressing SAVE/ENTER, *Save* will appear, showing the last program used on the screen. Press the ◀ ▶ keys to position the cursor on the number indicating the memory address, then press PREV/NEXT or rotate the encoder to select the memory where you wish to save the new program.

Note: A program that has not been saved is identifiable by the symbol * at the top right hand side of the display.

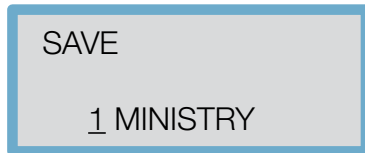

This symbol will only disappear once confirmation has been given that the program has been saved.

• Program naming

The program can be given a name using alphanumerical characters *up to 8 characters in length*. To input a new name, press ▶ to move the cursor to the "program naming" area of the screen. The screen will display the current name of the program that is about to be edited and the cursor will be underneath the first character to be changed. The characters can be changed by using the PREV/NEXT keys or the rotary encoder and the next character along can be selected using the ▶ key. Press the ◀ key to go back to change or correct previously set characters. Pressing SAVE/ENTER again will save the new settings unless the program address is protected.

• Program Lock

User programs can be protected to prevent automatic overwriting of memories. If the lock symbol appears while pressing SAVE/ENTER, the saving operation will fail. The "program locked" message will stay on the screen for a few seconds.

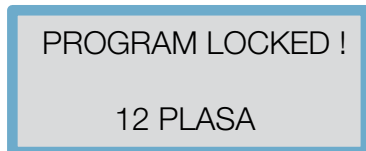

Once the message disappears, the program can be unlocked by using the NEXT key or rotating the encoder anticlockwise.

The saving operation will now be successful. After saving, the PS266 will ask you whether the program should be saved as *Locked* or *Unlocked*.

By rotating the encoder you will be able to select your required option. Then press SAVE/ENTER a third time to complete the operation.

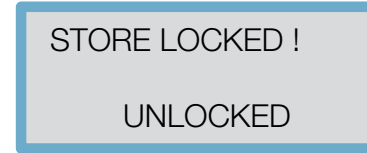
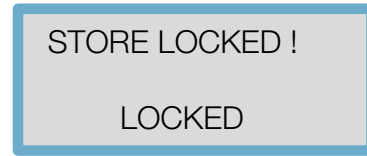

• Program recall

Pressing RECALL will enter the recall mode and the last program used will appear on the screen.

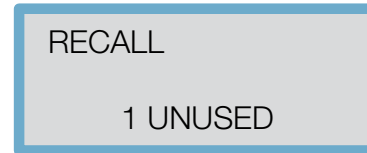

Use the PREV/NEXT keys or the rotary encoder to select the program you wish to recall. Only programs previously stored will be available for selection. Pressing RECALL a second time will recall the selected program.

• Program delete

From the main screen (showing the program being used) press PREV until Setup/Delete Prog appears, then press ◀, ▶ or rotate the rotary encoder to select the program you wish to delete. Press ENTER to confirm program deletion.

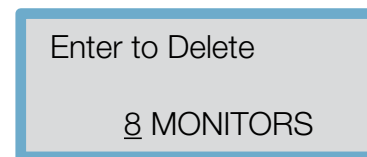
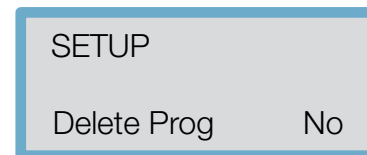

Pressing PREV/NEXT at any time will exit the Program Delete mode.

Note: Locked programs have to be unlocked before they can be deleted.

7.3 Configurations

Configuration is the controller main function and is saved as part of the Program information.

Changing this mode will reconfigure the overall *routing* and *linking* of the unit. The operation has to be confirmed as routing, linking, delay linking, and the crossover band name will be changed.

The unit will also mute the outputs to ensure that appropriate bandwidth settings can be checked before continuing.

Special system configurations are possible with the PS266. Select the configuration that matches most closely your requirements and, if necessary, change the parameters.

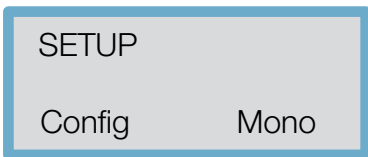

When a Setup is stored in a user memory, the configuration setting is saved as part of the program data.

To select the required configuration use the ◀ and ▶ keys or rotary encoder. Press ENTER to reconfigure the PS266 in the required setting. Pressing any other key will cancel the operation and restore the previous configuration.

• **Mono mode**

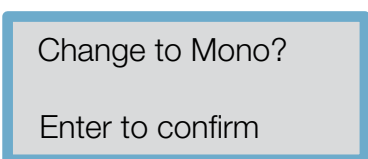

When choosing *Mono* configuration all the outputs will be routed through Input A.

Crossover frequencies are set as follows:

- OUT1: High pass OUT, Low pass 50.7 Hz
- OUT2: High pass 50.7 Hz, Low pass 159 Hz
- OUT3: High pass 159 Hz, Low pass 500 Hz
- OUT4: High pass 500 Hz, Low pass 1.62 kHz
- OUT5: High pass 1.62 kHz, Low pass 5.09 kHz
- OUT6: High pass 5.09 kHz, Low pass OUT.

Delay link defaults are set to Off and stereo connection will therefore be unavailable. Band names will change from *Band 1* to *Band 6* for the respective outputs.

• **2 channels – 3-way mode**

Use the rotary encoder or ◀ and ▶ keys to call up the screen below:

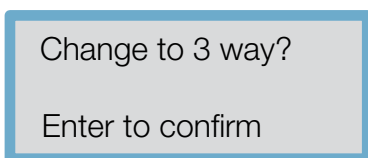

Press ENTER to confirm; this will call up the next instruction seen below. Note the * symbol on the top right-hand corner indicating that you need to save the selected configuration to make it operational.

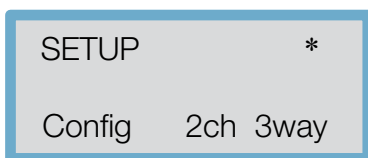

The configuration in *2 channels – 3-way mode* will be as follows:

- Outputs 1, 3 and 5 will be routed from Input A
- Outputs 2, 4, and 6 will be routed from Input B
- All delay linking defaults are off
- The stereo link will be on at all times
- Band names will be as follows:
 - 1: *Low*
 - 2: *Low*
 - 3: *Mid*
 - 4: *Mid*
 - 5: *High*
 - 6: *High*

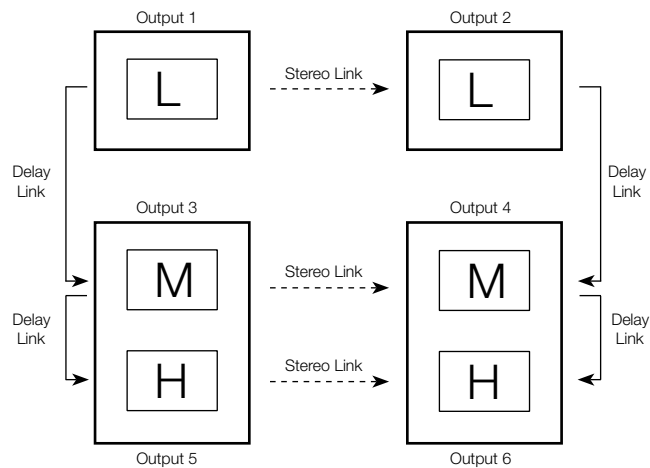
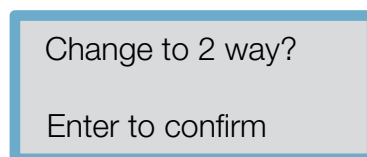

Figure 5. 2 channel- 3-way mode

• **LCR – 2-way mode**

Use the rotary encoder or ◀ and ▶ keys to call up the screen below:



Press ENTER to confirm; this will call up the next instruction seen below.

Note: the * symbol on the top right-hand corner indicating that you need to save the selected configuration to make it operational.

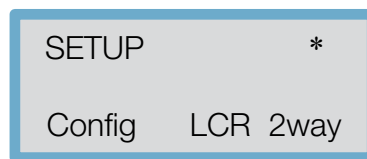

When using a central cluster system such as in *LCR (Left, Centre, Right)* installation, the configuration can be changed from 3 to 2 ways, where the centre channel is the sum of A and B.

The resulting configuration is as follows:

- Outputs 1 and 4 will be routed from Input A
- Outputs 3 and 6 will be routed from Input B
- Outputs 2 and 5 will be routed from A+B: Output 2 for low frequencies (High pass OUT, Low pass 1kHz) and Output 5 for high frequencies (High pass 1kHz, Low pass OUT)
- All delay linking defaults will be Off
- The stereo link will be On
- Band names will be set on *Low* and *High*.

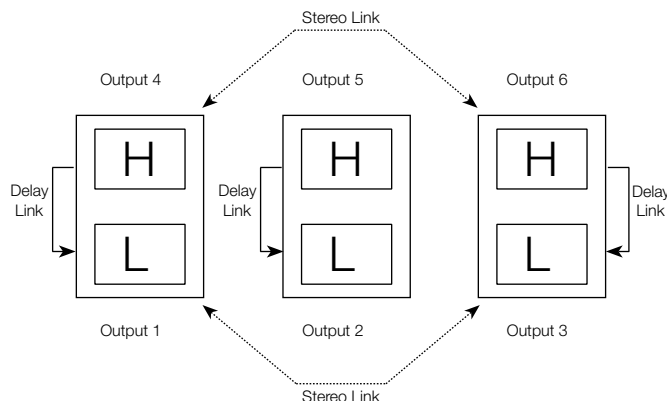
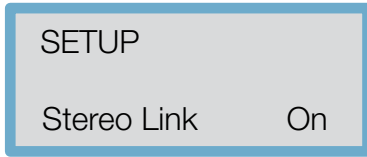

Figure 6. LCR – 2-way Mode

7.4 Stereo Link

This parameter adjusts the stereo linking of the various Input and Output parameters. This parameter is also stored as part of the Program data.



In 2 channel 3-way mode, Output pairs 1-2, 3-4, and 5-6 are linked, while in LCR 2-way mode Outputs 1-3 and 4-6 are linked.

• Step and Offset

There are two different types of link parameters: *Step* and *Offset*.

A *Step* parameter is characterized by discrete selections such as type of filter, high-pass slope, polarity and so on. When the channels are linked and a Step parameter is changed, e.g. the type of high-pass slope, the values of the two channels will necessarily be the same.

Offset parameters, by contrast, are not characterized by discrete selections but by a series of numerical values such as gain, frequency or delay. There can be offsets between these parameters when the channels are linked. Should one of the linked parameters reach the limit value, none of the other linked parameters can go above this limit.

Parameter	Linking Type	2 channel - 3 way	LCR - 2 way
Input Delay	Offset	A-B	A-B
Input EQ Type	Step	A-B	A-B
Input EQ Frequency	Offset	A-B	A-B
Input EQ ±	Offset	A-B	A-B
Output Name	Offset	1-2, 3-4, 5-6	1-3, 2-4
Output Source	Offset	A(1,3&5)/B(2,4&6)	A(1,3&5)/B(2,4&6)
Output Gain	Offset	1-2, 3-4, 5-6	1-3, 4-6
Output Limit	Offset	1-2, 3-4, 5-6	1-3, 4-6
Output Delay	Offset	1-3,3-5,2-4,4-6	1-4,2-5,3-6
Output Delay Link	Offset	1-3,3-5,2-4,4-6	1-4,2-5,3-6
Output Polarity	Step	1-2, 3-4, 5-6	1-3, 4-6
Output Lo Shape	Step	1-2, 3-4, 5-6	1-3, 4-6
Output Lo Frequency	Offset	1-2, 3-4, 5-6	1-3, 4-6
Output Hi Shape	Step	1-2, 3-4, 5-6	1-3, 4-6
Output Hi Frequency	Offset	1-2, 3-4, 5-6	1-3, 4-6
Output EQ Type	Step	1-2, 3-4, 5-6	1-3, 4-6
Output EQ Frequency	Offset	1-2, 3-4, 5-6	1-3, 4-6
Output EQ ±	Offset	1-2, 3-4, 5-6	1-3, 4-6
Output EQ Width	Offset	1-2, 3-4, 5-6	1-3, 4-6

Tab 1. Step & Offset

7.5 Crossover mode

This function allows the crossover slopes of the linked bands to be interconnected to make setting easier.

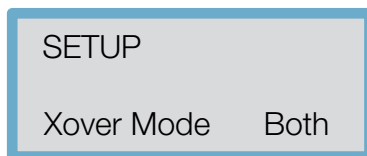

If, for example, they are in *Both* mode and we change the high-pass slope frequency of an output channel set up as e.g. 'Low' band, the low-pass slope frequency in the adjacent 'Mid' band output channel will also be changed.

The bands do not necessarily have to cross over at the same frequency, as an offset can be maintained between them.

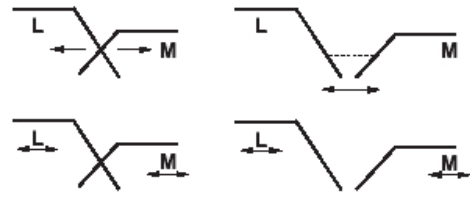
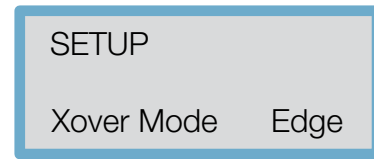

Figure 7. Both & Edge

When in Edge mode, by contrast, all the crossover slopes remain independently adjustable. This mode is useful when first setting up a system to adjust the response of every individual component/driver.



7.6 Delay units

Use the rotary encoder or ◀ and ▶ keys to call up the screen below:

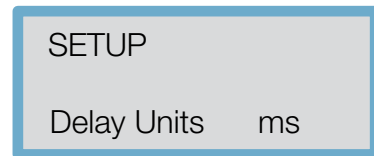

Delay units can be changed according to the specific application and are expressed in the following units of measurement:

- Milliseconds (ms)
- Frames per second (24, 25 & 30 fr/s)
- Feet (ft)
- Metres (m)

Use the ◀ and ▶ keys or rotary encoder to select the required measurement units. The latter allows you to view the delay value with the associated unit of measurement selected.

7.7 Protection

The unit has *three* levels of protection: *Lock Out*, *OEM Lock* and *Owner Lock*. They prevent the parameters and programs from being inadvertently changed or tampered with by unauthorized or unqualified users.

• Lock Out

This is the main security device. When Lock Out is on, none of the parameters can be adjusted (with the exception of Lock Out and the display Contrast), no Programs can be stored or recalled and the channels' Mute function cannot be activated/deactivated.

The appliance is protected against any accidental modification. To activate/deactivate Lock Out, move to the *SETUP*→*Lock Out* screen and use the rotary encoder or ◀ and ▶ keys to set Lock Out on/Off.

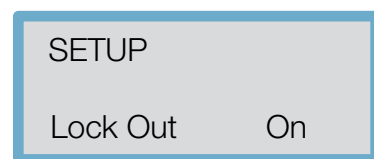

• OEM Lock

The OEM Lock allows the user to lock the adjustment of any or all of the parameters of a single program. These locks are stored with the program itself.

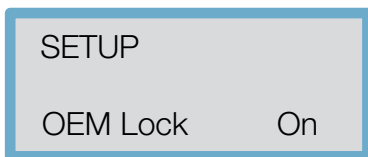

Pressing **▶** from the Utilities screen shown above displays the password screen with "OEM" showing as the password. To enter the password, use the rotary encoder to select the character and use the **◀** and **▶** keys to move the cursor.

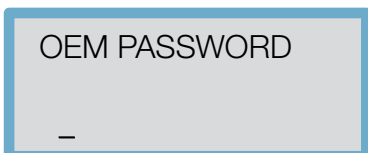

Should the password be incorrect, the relevant message will appear on the screen. In this case, you should go through all the steps to enter the password again.

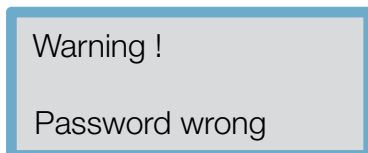

If the password has been entered correctly, briefly press SAVE/ENTER to call up the message below:

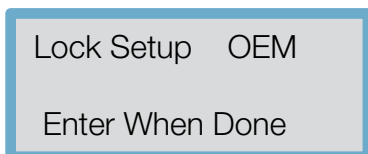

and the following message will then appear:

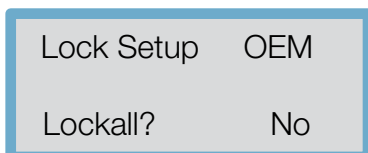

• Total Protection (Lock All)

This screen allows all the parameters to be locked immediately and they can then be unlocked at a later date. To lock all the parameters use **▶** or turn the rotary encoder clockwise until "Yes" appears.

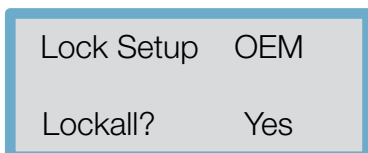

Press ENTER to continue.

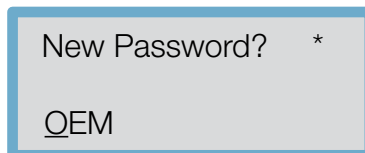

Enter a new password (select the characters with the encoder and move the cursor with the **◀** and **▶** keys) or confirm the suggested password (the last one used), then press ENTER. To unlock the protection, bring the following screen to "Off":

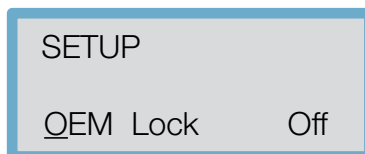

You will be asked for the password previously entered for the lock. Press ENTER to confirm and unlock the system.

• Lock set up mode

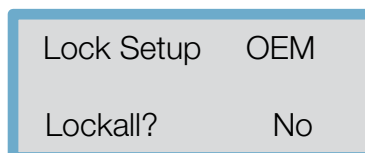

From the screen above relating to Lock OEM mode, it is possible to consider a further option.

Pressing PREV or NEXT again will in fact enter the Lock set up mode. Once in the Lock set up mode, it is possible to browse through the Input and Output screens as normal but with the following major differences:

- 1) parameter values can no longer be changed
- 2) the SAVE and RECALL screens will no longer be accessible
- 3) only the Config and Stereo Link Utilities will be lockable
- 4) the unit will always be unlinked.

If a parameter is unlocked, its name and value are displayed as usual. Pressing **▶** or rotating the encoder clockwise will lock the parameter which will then be displayed through a "check mark" as shown below:

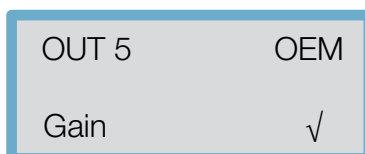

indicating that this parameter is now locked. The particular parameters to be locked can be selected browsing as usual by pressing the encoder (through the various routes) or the PREV/NEXT keys (within a single route). Conversely, if Lock All was selected, the parameters can be selected and changed by unlocking them. PEQs will not be displayed in Lock set up mode if they are unassigned, i.e. they have not been given any gain values.

Attempting to access a new EQ will display the following screen:

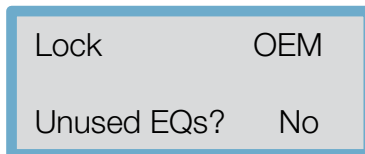

This allows the programmer to prevent a user from assigning further EQs. Alternatively the user can leave the ability to add other EQs.

If the PS266 is turned off while in Lock set up mode, the unit will return to locked once it is turned on again and the current password will still be valid.

IMPORTANT: Write down your password and keep it in a safe place. The security system cannot be deactivated without the password.

• Confirming the Lock selection

Once all the parameters are locked, confirm the lock set up process by pressing SAVE/ENTER.

At this stage, the unit returns to the screen displaying the current password. This password can be changed, if necessary, by using the ◀ and ▶ keys to move the cursor and the PREV/NEXT keys or rotary encoder to change the letters. Pressing SAVE/ENTER will save the password and the screen will return to the Utilities menu. The unit will now not display the locked parameters.

Should all the parameters of a specific Output or Input channel be locked, the selection key of that particular channel would not display the associated screens since none of the parameters can be adjusted. Unlocked parameters display as normal and can still be edited, although the associated program cannot be stored back in its original locked location but must be saved to a new user memory.

By cancelling the locked program through the Delete Program facility in the Utilities, it is possible to free up the memory location for further use. The screen below shows a program that has been OEM locked (indicated by the diamond symbol), and that unlocked parameters have been edited (asterisk).

The "*" symbol is not displayed in Lock set up mode.

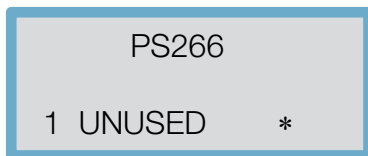

To return to Lock set up mode, change the selection of locked parameters, or turn the locks off altogether, select the Utilities mode and call up the Lock screen.

Press the ▶ key or rotate the encoder anticlockwise to display the password screen. Enter the password and press SAVE/ENTER: the lock will now be off.

• Owner Lock

This is a second level of security which works exactly in the same way as the OEM lock.

The only difference is that instead of 'OEM', the word 'Own' is displayed and the diamond shaped icon is replaced by the image of a padlock (top left-hand corner). It is possible to use both these modes to enable access to some parameters but not others. In this case, both the padlock and diamond symbols are displayed as a single icon. The password for the Owner lock is "SOMA".

7.8 Contrast

To change the display contrast, move to the SETUP → Contrast screen and use the ◀ and ▶ parameter keys or rotary encoder to increase/decrease the display contrast and viewing angle of the LCD.

A rotating line gives a visual indication of the parameter change.

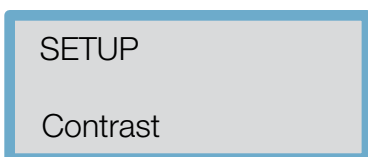

7.9 MIDI operation

• Channel Number (1-16)

MIDI is used to transmit and receive Program changes and to transmit system exclusive dump data between units. Move to the SETUP → MIDI Channel screen and use the ◀ and ▶ keys or rotary encoder to adjust the channel number from 1 to 16. To communicate correctly, both the sending and receiving equipment need to be set on the same MIDI channel.

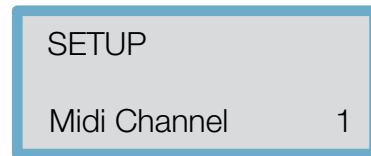

• MIDI mode

This mode sets the type of information the PS266 transmits on its MIDI Out socket and depends on how the PS266 is used in the system.

The following selections are available:

- OFF: No MIDI messages are transmitted except for system exclusive dumps.

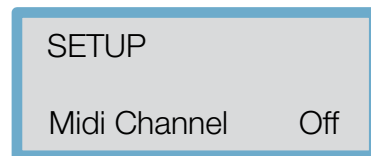

- PROGRAM (Prog): It enables the unit to transmit MIDI program changes.

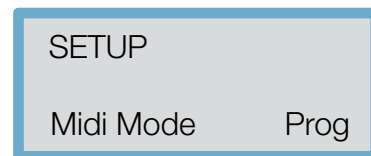

- MASTER: It enables transmission of all control changes to other devices on the same MIDI channel (to run two PS266 units in parallel for stereo applications, for example).

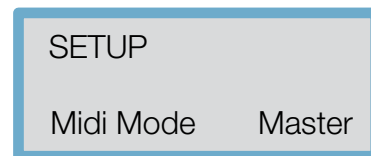

- THRU: It allows the throughput of data received at the MIDI In socket to the MIDI Out socket.

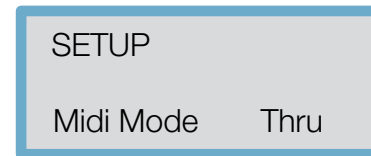

- PCPORT: This mode allows the RS232 port on the rear panel of the PS266 to be used to perform MIDI system exclusive dumps and to control other PS266 units.

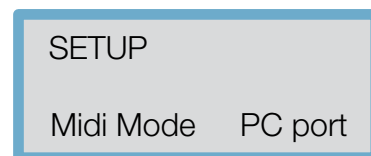

• MIDI Systems Exclusive Dump

This utility is used to transfer program information between PS266 units of the same model as well as to any *MIDI sysex (system exclusive)* capable sequencer or computer.

Connect the MIDI cable to the MIDI Out of the transmitter and to the MIDI In of the receiver then move to the *SETUP* → *Midi Dump*.

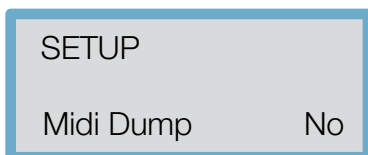

Pressing the ► key on the transmitter will display the prompt screen below

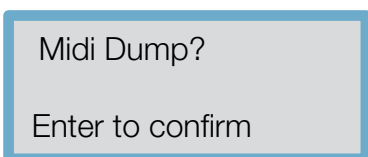

A MIDI sysex message will now be sent to the receiver warning of an incoming MIDI dump.

The PS266 receiver should display a message requesting authorization for the incoming dump. If you do not wish to have the memory of the PS266 receiver overwritten, press the ◀ key on the receiver to reply "No" to the prompt "Allow Dump?". The Receiver will return to normal operation and ignore all incoming program information.

Pressing PREV/NEXT at any time will return the transmitter to the Utilities mode. Press SAVE/ENTER on the transmitter to perform the dump.

The transmitter will now display the following screen.

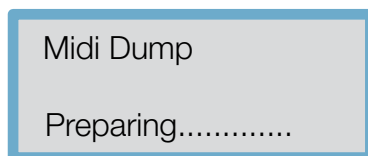

If communication is successful, a progress percentage will appear on the transmitter.

When it reaches 100%, the transmitter will return to the MIDI dump screen and the MIDI dump is complete.

Note: a system dump received by a different model could erase all the information stored in the memory of that unit. If you have many different models linked together, make sure that none of the units due to receive dump information are either switched off or set on another MIDI channel.

8. DSP FEATURES

8.1 Input channels

There are *three* input sections: *Input A*, *Input B* and *Input Sum (A+B)*. Delay and EQ can be added to Inputs A, B and stereo linked to A&B, but only the delay is applicable directly to the Sum A+B.

• Delay

Delay is applicable from 0 to 635 ms with 21µs steps for Input A, Input B and input A+B. Delay from any input to an output path cannot exceed 635.417 milliseconds. The unit of measurement for delay to represent this value, as either milliseconds, feet or frames per second, is set in the utilities section.

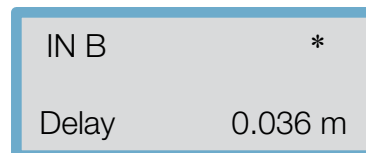

8.2 Output channels

There are *six* output sections: *Output 1 - Output 6*.

The output parameter screens can be accessed by pressing the PARAMETER button (press the encoder). If the outputs are connected in Stereo Link, different output combinations can be interconnected so that changing parameters (e.g. EQ and Crossover settings) will effect changes in both channels.

In *2 channel 3-way* configuration, the following outputs are paired: output 1 and 2, output 3 and 4, and output 5 and 6. In *LCR 2-way* configuration, outputs 1, 3 and 5 are linked, as are 2, 4 and 6.

When outputs are linked, the name band derives from the channel assigned to the lowest numbered output. Similarly, if the linked outputs are offset, the parameter value for the lowest numbered output is displayed. To see the values of the highest numbered output, turn the Stereo Link off.

• Output Name

The output band name can be selected from a pre-programmed list. Move to the OUT→ Name screen and use the ◀ and ► keys or the rotary encoder to scroll through the list. Choose the name that most closely describes the use of each channel.

Available names:

- L Low, L Mid, L High
- R Low, R Mid, R High
- C Low, C Mid, C High
- Subs, Low, Low Mid, Mid, Hi Mid, High
- Mid + High
- 1" Horn, 1.5" Horn, 2" Horn
- Bullet
- Flat
- Unused
- Bar, BStage
- Delay
- Centre
- Mono
- Aux
- Delay 1-6
- 10", 12", 15", 18", 21", 24"
- L Subs, C Subs, R Subs.

• Source

This allows selection of the input channel to assign to a particular output (in case of *Mono* mode).

The options are: Input A, Input B or the sum of both (SUM A+B). When connected in stereo 2 channel 3-way mode, the selection is normally Inputs A&B.

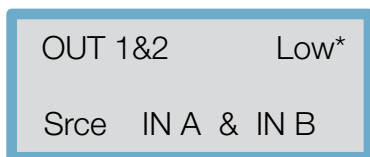

• Gain

Output channel gain can be adjusted from -15 dB to +15 dB with 0.2 dB steps. The nominal setting for outputs is 0 dB.

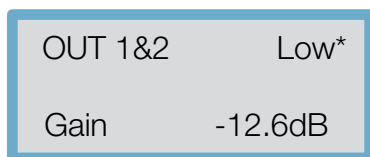

• Limiter

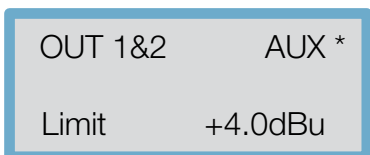

Every output channel has a limiter that can be set to any threshold between -10 and 20 dBu. Limiters perform two important functions: to prevent amplifier clipping and to limit the amount of power transmitted to the transducers. In applications whose systems need to operate at high volume levels for long periods of time, setting the correct limiter threshold is crucial for protecting the speaker drivers. The value set in this screen is also the metric reference value of the output channel.

If the limiter is set to 2.0 dBu, the output measurement for the selected channel will represent a limit of +2dBu with a reading of -3, -6, -12 and -30 dB relevant to that level, i.e. -1 dBu, -4 dBu, -10 dBu, -22 dBu and -28 dBu. Limiters are normally set slightly below maximum settings.

Limiter level calculations

The method for setting the threshold value is given by the following equation:

$$\text{Threshold limit (dBu)} = \text{Transducer voltage limit (dBu)} - \text{Amplifier gain (dB)}$$

• Delay

The delay for the output or input channels can be adjusted from 0 to 635 ms, in 21µs steps.

At no time can there be a delay of over 635 ms on any input and output path. Use the ◀ and ▶ keys to select delay values in 21µs steps and the rotary encoder for quicker delay selection.

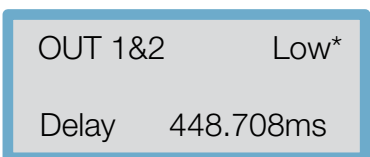

• Delay linking

This is used to maintain the offsets between the various channels. Typical uses include setting of the Offset delay of individual transducers for maximum performance (e.g. driver alignment). Should the delay be changed, the connected channel will follow and maintain the Offset.

Normally the transducer delays are set first, followed by any overall delay for cluster or delay tower alignment.

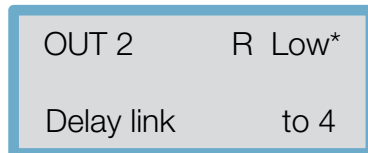
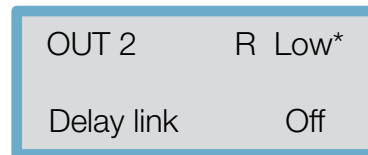

The following table shows the linkable channels for each mode.

Output	Mono	2 channel - 3 way	LCR - 2 way
1	2	3	4
2	3	4	5
3	4	5	6
4	5	6	None
5	6	None	None
6	None	None	None

Table 2. Linking

When using Delay Linking, we recommend using the following adjustment order:

- Driver alignment within cabinets
- Cabinet alignment within clusters
- Delay alignment between clusters

In 2 channel 3-way and LCR configurations, the default settings include both Delay Linking and Stereo Linking.

• Polarity

The polarity of the input signal can be reversed using the ◀ and ▶ keys or rotary encoder. If the polarity is changed on a linked output, both outputs will change to the same selection.

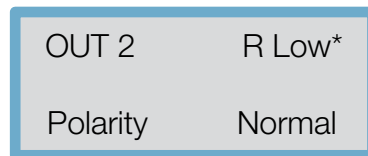

• High pass filter (HPF)

The high-pass filter can be selected among the following types: Bessel 12, 24 dB/Oct; Butterworth 6, 12, 18, 24, 48 dB/Oct; Linkwitz-Riley 12, 24 and 48 dB/Oct.

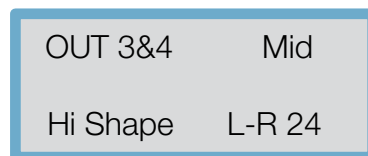

The options are displayed as follows: BUT6, BUT12, BES12, L-R12, BUT18, BUT24, BES24, L-R24, BUT48 and L-R48.

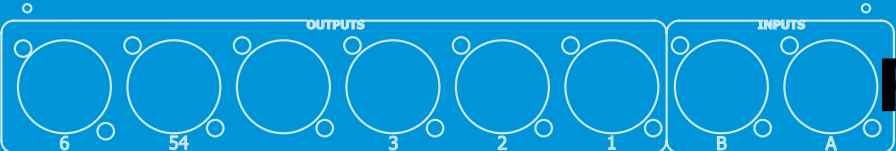

• HPF Frequency

This control adjusts the cut-off frequency of the selected crossover (high-pass). The range is from 15 Hz to 16 kHz in 1/6 Octave steps; under 15 Hz the filter is disabled (*Out*), while 16 kHz is the limit of the device frequency response. To adjust the cut-off frequency of the high-pass filter use the encoder or ◀, ▶ keys.

OUT 3&4	Mid
Hi pass	101Hz

Note: if the filter frequency exceeds 16 kHz, the output channel turns off.

• Low pass filter (LPF)

The filter cut-off frequency can be selected from among the following types: Bessel (12, 24 dB/Octave); Butterworth (6, 12, 18, 24 or 48 dB/Octave); Linkwitz-Riley (12, 24 and 48 dB/Octave).

OUT 3&4	Mid
Lo pass	L-R 24

The options are displayed as follows: BUT6, BUT12, BES12, L-R12, BUT18, BUT24, BES24, L-R24, BUT48 and L-R48.

• LPF Frequency

This control adjusts the cut-off frequency of the selected low-pass crossover. The range is from 15 Hz to 16 kHz in steps of about 1/6 Octave; over 16 kHz the filter is disabled (*Out*). To adjust the cut-off frequency of the low-pass filter use the encoder or ◀ and ▶ keys.

Out 3&4	Mid
Lo pass	1.00kHz

8.3 Equalization

Multiple EQs can be assigned to individual input and output channels. If there is no EQ on the currently selected channel (where filters are available), the PREV key will step into an unused *Bell EQ* with 1 kHz frequency, 0 dB cut/boost and 0.3 width.

Provided this EQ is used first, further EQs can be assigned to a single channel by applying various degrees of cut or boost; pressing PREV again will enter into a new EQ.

The EQ parameters are: *EQ type* (Bell, High Shelf 12 dB, High Shelf 6 dB, Low Shelf 12 dB, Low Shelf 6 dB), *frequency*, *gain* and *width* (for Bell filters only).

• EQ Input

It is possible to assign an EQ to inputs A, B (and A&B). High and Low Shelving with 12 dB or 6 dB/Octave slopes as well as parametric (bell) curves can be used. To add EQ to Input Sum A+B, adjust EQ parameters on the individual unmixed inputs (A, B) which are then summed into A+B Inputs.

IN A & IN B	*
Eq1S	Bell Sp12

• EQ Output

The screen below shows the first EQ on outputs 1&2 (labelled as "Low"). A 12 dB *Low Shelf* filter has been selected and there are currently 26 spare filters still available.

OUT 1&2	Low
Eq1S	Lo12 Sp26

• EQ Frequency

EQ frequency is adjustable from 15 Hz to 16 kHz in 1/6 Octave steps. The screen below shows the first EQ on Output 2 (labelled as *Low*). It has a frequency of 1 kHz.

OUT 1&2	Low
Eq1S	Fq 1.00kHz

• EQ Gain

Selectable gain from -15 dB to +15 dB in 0.2 dB steps. Setting an EQ cut/boost to 0 dB will de-assign the filter, allowing it to be assigned to another channel.

OUT 1&2	Low
Eq1S	+ - +3.0dB

• EQ band

Bandwidth is only available for Bell EQ, from 0.05 to 3 Octaves in 0.05 Octave steps.

OUT 1&2	Low
Eq1S	Wd 1.600Oct

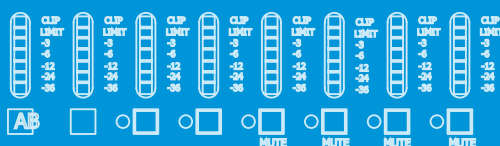

• EQ graphs and filter responses

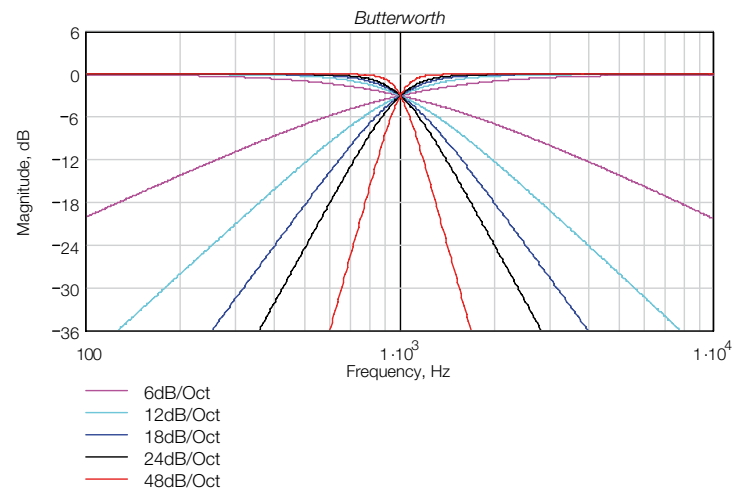
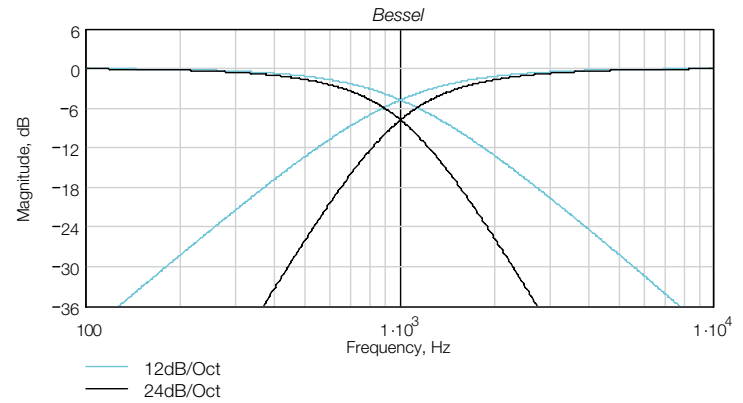
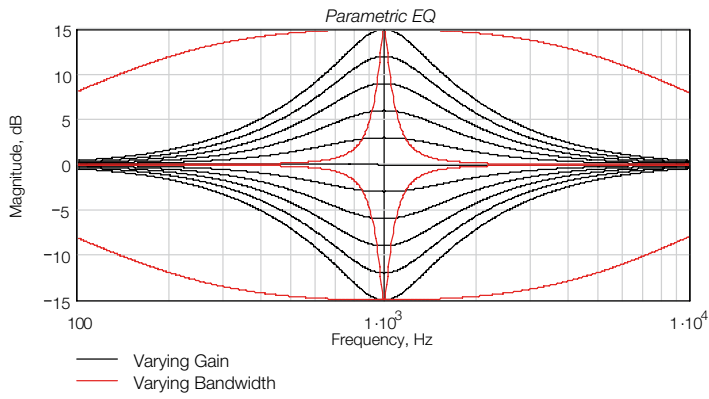
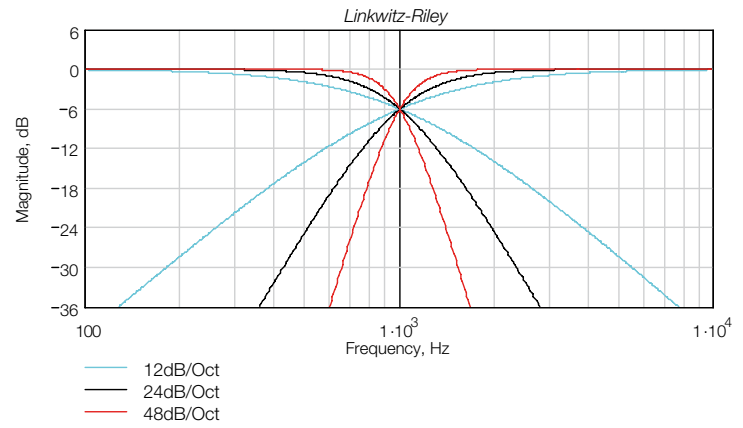
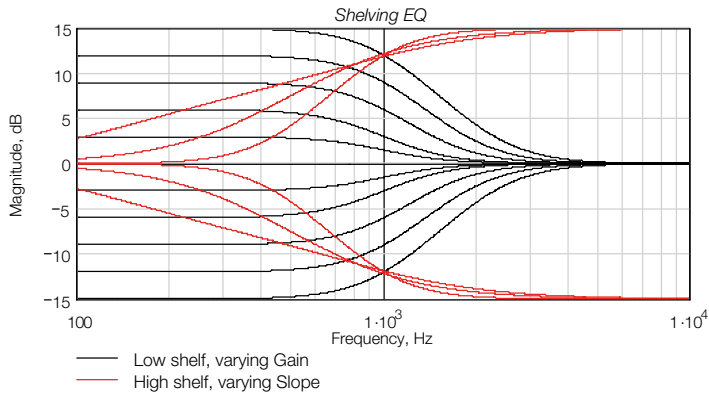

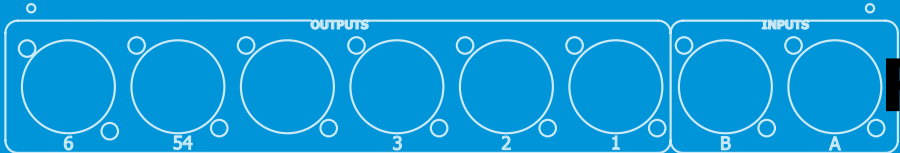

• DSP structure

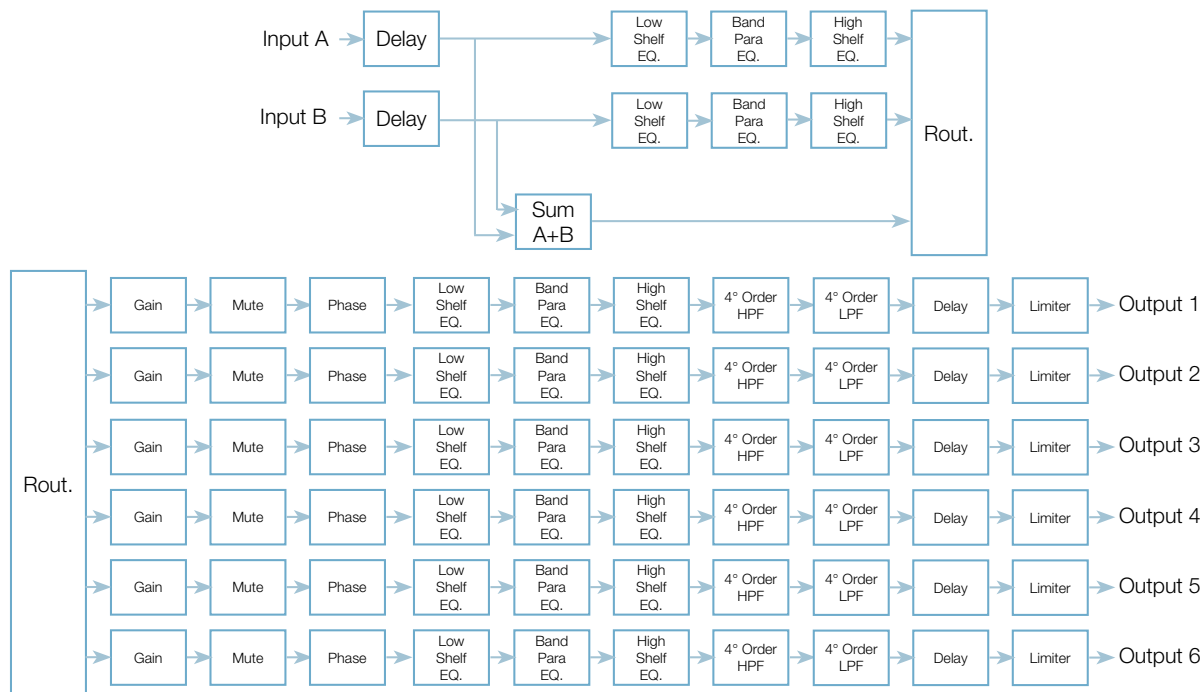

9. TECHNICAL SPECIFICATIONS

Input Channels	2
Input Gain	-15 ÷ +15 dB
Output Channels	6
Output Gain	-15 ÷ +15 dB
Output Polarity	norm, invert
Output HPF Freq.	15 Hz ÷ 16 kHz
Output HPF Shapes	But6, But12, But18, But24, But48, Bes12, Bes24, LR12, LR24, LR48
Output LPF Freq.	15 Hz ÷ 16k Hz
Output LPF Shapes	But6, But12, Bes12, LR12, But18, But24, Bes24, LR24, But48, LR48
Output Limiter Threshold	-10 ÷ +20 dBu
Parametric EQ. Freq.	15 Hz ÷ 16k Hz
Parametric EQ. Width	0.05 ÷ 3 octaves (0.05 step)
Parametric EQ. Gain	-15 ÷ +15 dB
Shelving EQ. Freq.	15 Hz ÷ 16 kHz
Shelving EQ. Gain	-15 ÷ +15 dB
Delay	0 ÷ 635 ms (21 µs step)
PC Remote Control	Digital Speaker software
Input Impedance	10 kΩ, electronically balanced
Output Impedance	<50 Ω, electronically balanced
Max Input Level	20 dBu
Max Output Level	20 dBu (@ 600 Ω)
DSP Word Code	24 bit
DSP Sample Rate	48 kHz
Frequency Response	15 Hz ÷ 20k Hz (± 0.25 dB) 15 Hz ÷ 40k Hz (± 3 dB)
Dynamic Range	>112 dBA typ (20 Hz ÷ 20 kHz)
THD	<0.008% (20 Hz ÷ 20 kHz)
Power Requirements	90-250 VAC, 50/60 Hz
Power Consumption	<25 W

Connectors

Audio Inputs	3-pin female Neutrik® XLR
Audio Outputs	3-pin male Neutrik® XLR
Comms	9-pin female DE-9 5-pin MIDI
Mains	3-pin IEC

Environmental

Temperature	0 ÷ +55 °C
Humidity	0 ÷ 80% RH (non-condensing)

Dimension and Weight

Height	44 mm (1 Rack Unit)
Width	483 mm (19")
Depth	225 mm
Net Weight	3 kg

Regulatory Compliance

This product complies with the *EMC Directive 89/336/EEC* as issued by the *Commission of the European Community*.

Compliance with these directives implies conformity with the following European standards:

- EN55103-1 Electromagnetic Interference (*Emission*)
- EN55103-2 Electromagnetic Susceptibility (*Immunity*)
- EN60065 Electrical Safety (*Safety*).

The PS266 Speaker Management System meets the requirements of UL6500 (Electrical Safety) and FCC part 15B (EMC).

This product is intended for operation in the E2 (*commercial & light industrial*) and E3 (*urban outdoors*) Electromagnetic Environments.