

PS amps

USER'S MANUAL



peecker sound®

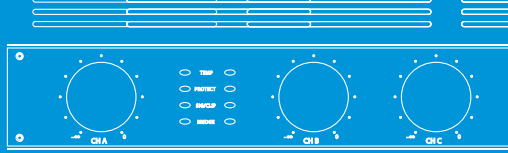
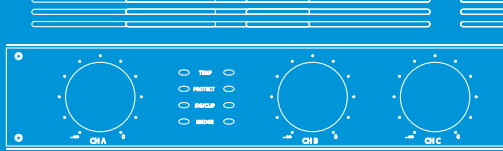

TABLE OF CONTENTS

| | |
|--|----------------|
| TABLE OF CONTENTS | |
| 1. IMPORTANT SAFETY INSTRUCTIONS | pag. 3 |
| 2. DECLARATION OF CONFORMITY | pag. 3 |
| 3. WARRANTY | pag. 3 |
| 4. USER LIABILITY | pag. 4 |
| 4.1 Damage to speakers | |
| 4.2 Dangerous output voltage | |
| 4.3 Radio interferences | |
| 5. INTRODUCTION | pag. 4 |
| 5.1 Unpacking | |
| 5.2 Installation | |
| 5.3 Front panels | |
| 5.4 Rear panels | |
| 6. BRIEF DESCRIPTION OF THE SERIES | pag. 7 |
| 7. OPERATING INSTRUCTIONS | pag. 8 |
| 7.1 Connection to the AC mains supply and power absorption | |
| 7.2 Cooling | |
| 7.3 Connection cables | |
| 7.4 Configurations | |
| 8. PROTECTION SYSTEM FEATURES | pag. 10 |
| 8.1 Limiter | |
| 8.2 Thermal protection | |
| 8.3 Load safety control | |
| 8.4 DC protection | |
| 8.5 Power on/off transients | |
| 9. TESTING PROCEDURE FOR ELECTRO-MECHANICAL OPERATION | pag. 10 |
| 9.1 Required equipment | |
| 9.2 Visual check | |
| 9.3 Electrical testing procedures | |
| 10. TECHNICAL SPECIFICATIONS | pag. 12 |



1. IMPORTANT SAFETY INSTRUCTIONS



This symbol indicates *key operating instructions and information* requiring particular attention for correct use of the product.



This symbol warns of *dangerous voltage* and the consequent risk of electric shock. Take extra care and proceed with caution.

1. Read carefully all the attached product documentation and keep for further reference.
2. Heed the warnings.
3. Keep the packaging and check that all the material is in perfect condition.
4. Do not use the product in the vicinity of water or pour water or any other liquid on the amplifier. Take care not to use it with wet hands or with your feet in water.
5. Do not use near sources of heat such as radiators, stoves or other heat-producing appliances.
6. Check that the power cable is intact and undamaged. Do not tread on the cable and take care not to put any pressure on the plug.
7. Connect the plug to a properly earthed electric socket. Do not tamper with the plug. Should the plug supplied not fit your socket, have an electrician replace it with the correct one.
8. Connect to the mains supply having identical voltage as that indicated on the back of the amplifier.
9. Install the amplifier in compliance with the instructions.
10. Do not obstruct the air ducts.
11. Disconnect the appliance in case of storms or when not in use.
12. Wire exclusively as shown in the instructions.
13. Do not remove the upper or lower covers as this would expose the user to the risk of electric shock.



14. Do not attempt to repair the appliance yourself but always seek the assistance of qualified technicians.
15. Do not connect an input signal higher than that indicated in the manual.
16. Do not connect the amplifier output to the input of another channel.
17. Do not connect the amplifier output to any other power source such as batteries, power supply unit or mains outlets, regardless of whether the amplifier is switched on or off.
18. Clean with a dry cloth only.
19. The product must be handled by qualified technicians when:
 - the power cable or the plug is damaged
 - the product has been exposed to rain or humidity
 - liquid has got inside the unit
 - an object has fallen on the unit
 - the unit has fallen and is damaged
 - the appliance seems to be malfunctioning or is showing a marked change in performance
20. Careful supervision is required if the product is used in the presence of children or by unskilled adults.
21. This appliance may produce sound pressure levels damaging to the hearing. Take the utmost care and do not use the product for long periods of time at high or uncomfortable volume levels. Should you experience any hearing loss or buzzing in your ears, consult an audiometric specialist.

2. DECLARATION OF CONFORMITY

This device complies with the requirements of the *European Electromagnetic Compatibility Directive* 89/336/EEC and relevant 92/31/EEC amendment, as well as the requirements of the *Low Voltage Directive* 72/23/EEC and relevant 93/68/EE amendment.

Regulations applied:
 EN55103-1 (*Emissions*)
 EN55103-2 (*Immunity*)
 EN60065, Class I (*Safety*).



3. WARRANTY

Peecker Sound products are guaranteed against malfunction due to defective materials or workmanship for a specified period of time, starting from the date of original purchase. Should a malfunction occur during the warranty period, the product will be repaired or replaced (at the manufacturer's discretion) free of charge. The shipping costs and related risks, and any loss during shipment to authorized service centres are the responsibility of the customer. The product will be returned to the customer with a carriage forward shipment.

Warranty terms

The warranty covers the appliance under its initial purchase in compliance with the laws in force. The warranty is valid for **3 years**, starting from the date of receipt of the product. Peecker Sound reserves the right, in certain cases, to decide to replace the appliance with another identical or similar product. The warranty is not extended following a product failure. The warranty does not cover any incidental or consequential damages, without limitation, caused to persons or property during any period of inefficiency of the appliance.

Exclusions and limitations

The warranty does not apply to:

- any damage to exterior finishings or surfaces, aesthetic elements, or electric/electronic parts resulting from negligent use of the product;
- malfunction resulting from incorrect or improper use of the product or from transport without due care;
- malfunction resulting from repairs carried out by unauthorized persons or service centres;
- malfunction due to circumstances that cannot be ascribed to manufacturing defects of the appliance;
- plastic or glass parts, bulbs and the like, as well as all that can be regarded as normal wear and tear. As regards circuit components (transistors, diodes, etc.) the general terms set by the original manufacturers apply.

The following are also not covered by the warranty:

- damage caused by accidents, product modifications, negligence or incorrect connection
- damage that occurred during transport
- damage resulting from failure to comply with the instructions contained in the user's manual
- claims based on misrepresentations by the seller and any product whose serial number has been rubbed off, modified or removed.

Receiving warranty service

To receive repair or replacement of the product under warranty, the customer must deliver the product in its original packaging carriage paid to an authorized Peecker Sound service centre together with the relevant proof of purchase, i.e. bill of sale, receipt or invoice.

The warranty service and list of authorized service centres is available at the address below:

Peecker Sound - "After Sales Service"

Via Monti Urali, 29 - 42100 Reggio Emilia (Italy)
 Tel: +39 0522 557735 - Fax: +39 0522 391268
 E-mail: info@peeckersound.com

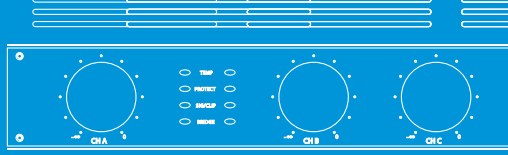

Repair or replacement of the product and its return to the customer are the only services provided to the customer. Peecker Sound shall not be held liable to pay incidental or consequential damages including, without limitation, injury to persons or property or loss of use.

Costs paid by Peecker Sound

Peecker Sound will pay for all labour and material expenses necessary for the repairs covered by the warranty. Make sure you keep the original packaging; otherwise, the cost of replacing will be charged to you if necessary. Produce the original invoice to establish the date of purchase.

Do not send the product to the factory without prior authorization. Should shipment of the product be a problem, please contact the service centre, who will deal with it promptly. Otherwise, the customer is responsible for shipment and handling of the product to be repaired and payment of all shipping costs.

Limitation of implicit warranties

All implicit warranties, including guarantee of merchantability and suitability to specific purposes, are limited to the duration of the present warranty. With the exception of certain types of damage, Peecker Sound liability is limited to repairing or replacing, at its discretion, any defective products, with no obligation of compensation for any kind of incidental or consequential damages. In case of any controversy, the court of jurisdiction will be exclusively the Court of Reggio Emilia (RE) – Italy.

4. USER LIABILITY

4.1 Damage to speakers



Check the peak power and continuous power of the amplifiers at all times. These amplifiers are extremely powerful and may be potentially dangerous to both speakers and human beings.

Most loudspeaker systems may be easily damaged or broken, often if they are driven by *bridged* amplifiers. Although the gain may be attenuated by using the controls on the front panel of the amplifier, the maximum power output can still be reached if the input signal is sufficiently high.

4.2 Dangerous output voltage



Amplifiers can generate dangerous output voltage. Do not touch any exposed speaker cables while the amplifier is operating.

4.3 Radio interferences

A sample of this product has been tested and approved in compliance with the limits set out by the *Electromagnetic Compatibility Directive* (EMC). These limits have been determined in order to provide reasonable protection from dangerous interferences caused by electrical appliances.

Should this product not be installed or used in compliance with the instructions as set out in this manual, it might interfere with other appliances such as radio receivers, for example. There is no guarantee, however, that interferences will not occur in a particular installation.



Should the device interfere with two-way radios (switching the device on and off will allow you to check whether this is the case), you should try to eliminate the interference by adopting one of the following measures:

- Increase the distance between the appliance and the receiver.
- Connect the appliance to a socket positioned on a circuit different from which the receiver is connected to.
- Re-position or move the aerial of the receiver.

Check that the unit complies with the EMC immunity limits (it must carry the CE mark). All electrical appliances sold in the EU must be approved for immunity to electromagnetic fields, high voltage and radio interferences. Seek professional assistance.

5. INTRODUCTION

Congratulations on your choice of a Peecker Sound **Professional Series** power amplifier and thank you for your confidence in us and our products. Your amplifier has been carefully engineered down to the smallest detail, from component selection to final assembly. All Peecker Sound products aim for full customer satisfaction and you can rest assured that the product you have chosen uses cutting-edge technology.

The amplifiers have been designed in the Sound Corporation Design and Research&Development (R&D) departments paying particular attention to the choice of materials, safety devices and electronic design for the manufacture of a safe, reliable and long-lasting product.

Since inappropriate use of the product can jeopardize its correct operating performance, please ensure that you use it carefully and correctly. Please read this manual carefully: all the information it contains is vitally important for using your appliance safely.

5.1 Unpacking

Inspect the packaging and its contents immediately to check whether there are any signs of damage. After unpacking, inspect the product and any accessories. Should you notice any damage, inform your dealer immediately.

Please keep all the packaging materials, which will be useful for returning the product to Peecker Sound or sending it to one of our authorized Service Centres if the product does not arrive in perfect condition. Use exclusively the original packaging, as it is the best way to protect the appliance from mishandling by the carrier.



Please take care of the environment. Once the appliance has become obsolete, please dispose of it in the appropriate recycling container.

5.2 Installation

All Peecker Sound **Professional Series** models can be installed in standard 19" rack units as shown in Fig. 2. There are four installation holes on the front panel for optimal securing of the appliance – an important factor in mobile systems.

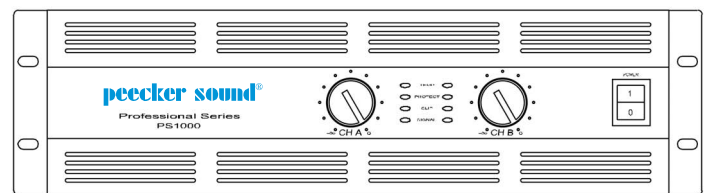

483 mm

Figure 1. PS amplifier dimensions



Figure 2. Flight case for pro amplifiers

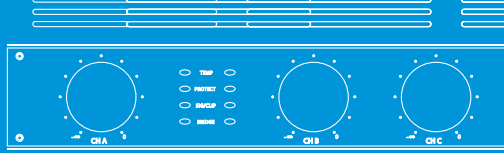

5.3 Front panels

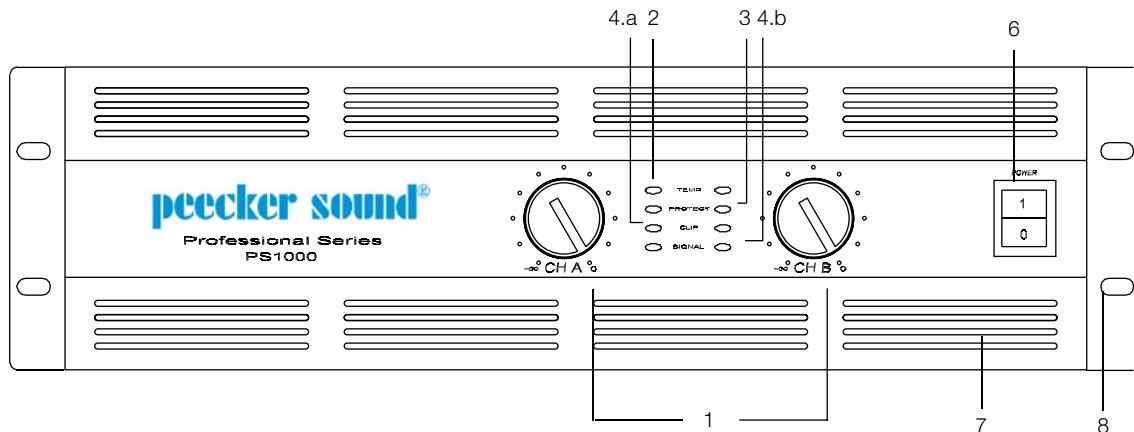

Figure 3. PS1000 – PS1400 – PS2000 – PS2600 – PS3400 Front panel

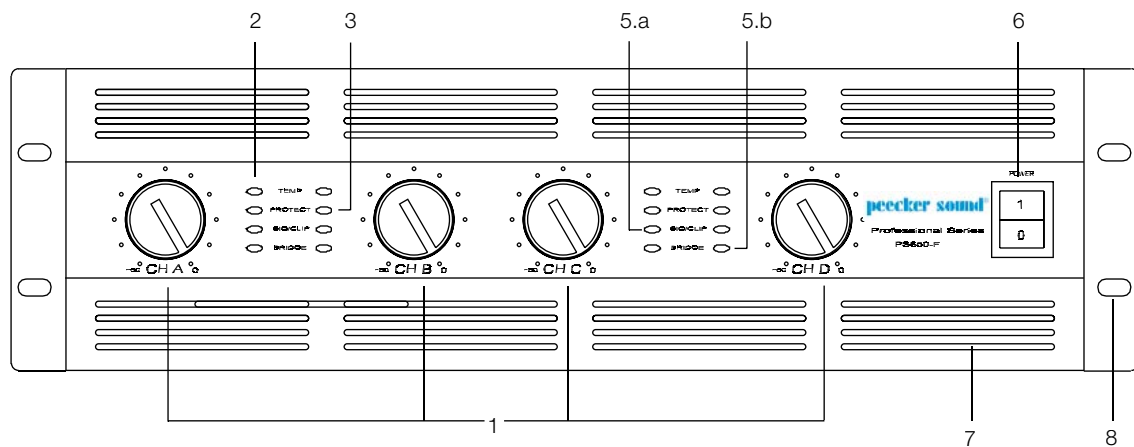

Figure 4. PS650-F front panel

1. CHA/CHB (CHC/CHD) - Precision input level controls that allows the amplification level of each channel to be adjusted.



Note: when using in *bridged* mode (only applicable to PS650-F, PS1000 and PS1400 amplifiers), the various level attenuators must be in the same position. We recommend setting them on the 0 position.

2. TEMP - When the temperature LED lights up, the channel gets deactivated as a protection measure against overheating. The fan will continue to operate so as to bring the temperature down as quickly as possible.



Note: this situation normally occurs when there is inadequate ventilation. Check the amplifier installation carefully.

3. PROTECT - This protection LED lights up when the load connected is below 1 Ω or the amplifier output has been short-circuited.

4.a) CLIP - LED indicator for input signal clip point.
4.b) SIGNAL - LED indicator for signal presence.

5.a) SIG/CLIP - Dual-mode LED indicator for both signal presence (*green*) and signal clip point (*red*).
5.b) BRIDGE - LED indicator for amplifier operating in bridged mode.

6. POWER - On/Off switch.

7. Ventilation grille for correct amplifier ventilation.

8. 19" rack installation holes.

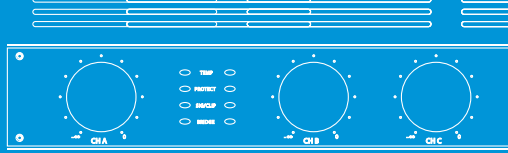

5.4 Rear panels

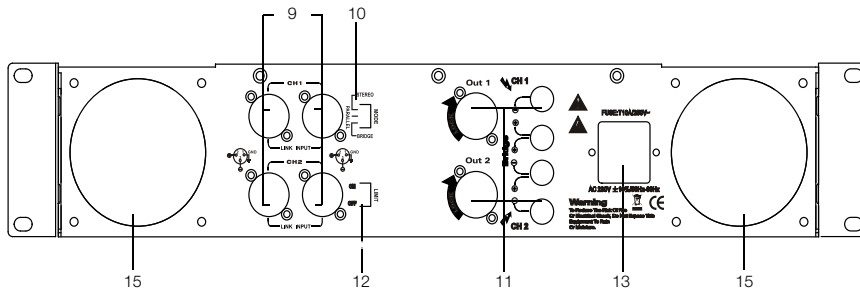

Figure 5. PS1000 rear panel

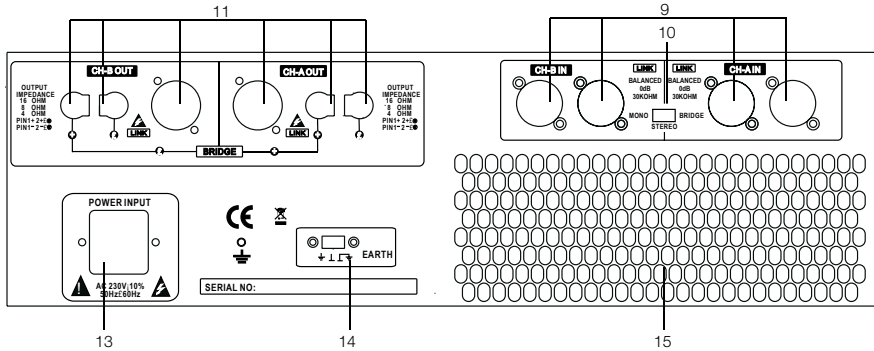

Figure 6. PS1400 rear panel

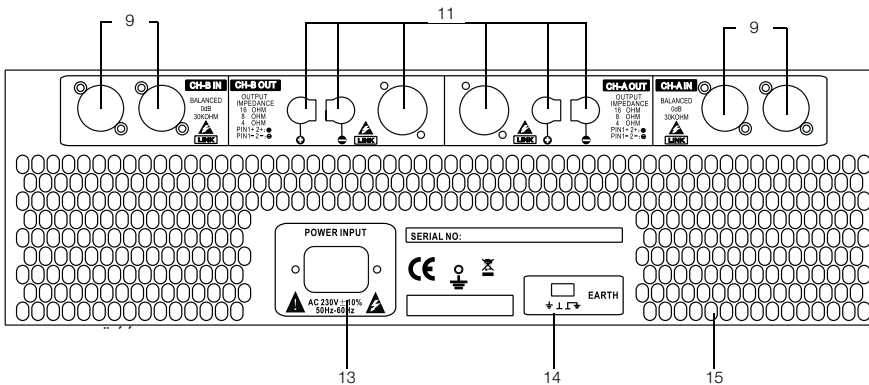

Figure 7. PS2000 - PS2600 - PS3400 rear panel

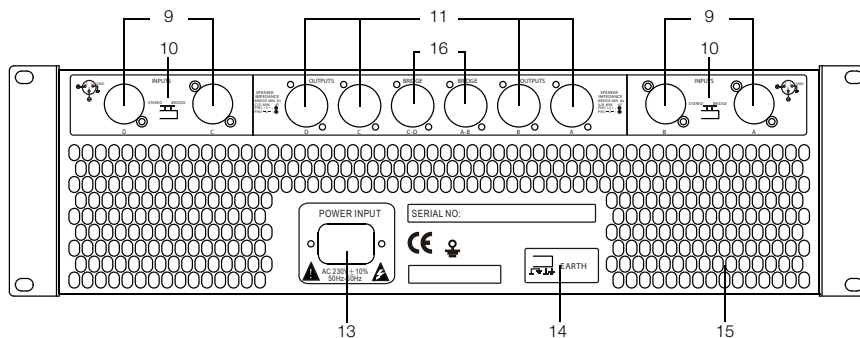
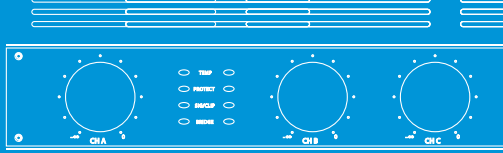

Figure 8. PS650-F Rear panel

- 9. **Inputs (CHA IN/ CHB IN)** – Cannon® XLR inputs for each channel.
- 10. **Operating mode switch** – Operating mode selection switch: *mono, stereo, parallel* or *bridge*.
- 11. **Outputs (CHA OUT/ CHB OUT)** – Neutrik® SpeakOn output connectors for each channel.
- 12. **Limit** - Limiter control switch. LIMIT ON: soft clip limiter enabled, LIMIT OFF: disabled.
- 13. **Power Input** – IEC 3-pin power supply connector.
- 14. **Earth** - Ground lift that allows connection-disconnection of electrical earth to/from mechanical earth.
- 15. Ventilation grille.
- 16. **Bridge** - CHA-CHB, CHC-CHD outputs with Neutrik® SpeakON connectors for bridge mode.



6. BRIEF DESCRIPTION OF THE SERIES

Professional Series amplifiers are available in six models, differentiated according to power ratings and number of channels.

PS1000, **PS1400**, **PS2000**, **PS2600**, and **PS3400** models are two-channel amplifiers capable of delivering from 450 W up to 1700 W per channel onto 4 Ω. **PS650-F** model, by contrast, has four 650 W channels, also onto 4 Ω.

All Professional Series amplifiers have been designed to meet the specific requirements of the world of professional audio based on criteria of maximum reliability and ease of use. Power delivery remains constant even at high loads, with low heat dissipation and high performance thanks to low-leakage toroidal transformers, which provide an extra margin above the stated nominal output. The power supply unit is protected against possible overvoltages, overheating and short circuiting.

Each of the power stage modules is fully independent in terms of both electrical and thermal protections. Each channel, in fact, is equipped with its own heat sink and independent temperature control which acts directly on the cooling fan.

The signal is constantly monitored, with the LED light on the front panel checking and indicating the level.

An internal limiter provides loudspeaker system protection against signal distortion. The mechanical construction and subsequent circuit engineering are such as to guarantee high production standards. Thanks to its rigid steel chassis, the amplifier is able to withstand even the toughest tours, guaranteeing maximum reliability in all operating conditions.

Plus

- **Multi-application**
- **High-technology**
- **Durability**
- **High power & efficiency**



PS1000

Output Power @ 4 Ohm **2 x 450 W***

Output Power @ 8 Ohm **2 x 280 W***



PS1400

Output Power @ 4 Ohm **2 x 700 W***

Output Power @ 8 Ohm **2 x 450 W***



PS2000

Output Power @ 4 Ohm **2 x 1000 W***

Output Power @ 8 Ohm **2 x 650 W***



PS2600

Output Power @ 4 Ohm **2 x 1300 W***

Output Power @ 8 Ohm **2 x 850 W***



PS3400

Output Power @ 4 Ohm **2 x 1700 W***

Output Power @ 8 Ohm **2 x 1000 W***



PS650-F

Output Power @ 4 Ohm **2 x 650 W***

Output Power @ 8 Ohm **2 x 300 W***

* EIA 1 kHz - 1% THD, both ch.s driven @ 230 VAC

SOUND REINFORCEMENT

CONTROLLED RADIATION

ACOUSTIC RESEARCH

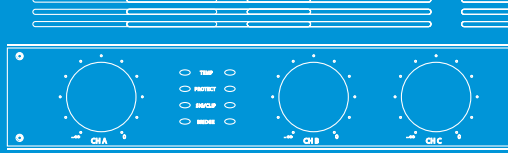

7. OPERATING INSTRUCTIONS

7.1 Connection to the AC mains supply and power absorption

Check that your mains power supply is sufficient for the power requirement of your amplifier (consult the data at the end of this manual). Note that the voltage of the electric mains should correspond to the voltage indicated on the back of the amplifier. Maximum current absorption is limited by internal fuses.



Note: Remember that before connecting any of the cables it is always better to switch off and disconnect the amplifier from the power supply. When switching on the amplifier, the volume controls should always be set to the lowest level.

7.2 Cooling

Pay particular attention to the ventilation/cooling conditions of the amplifiers. An internal system of forced airflow by means of a variable speed fan allows the heat sinks to cool down from the heat generated by power parts. The air flows from the front panel of the amplifier to its rear panel, so that the air is drawn in from the front opening and let out through the back opening.

Ensure that there is sufficient space in front of the appliance to allow adequate inflow and outflow of air. With rack installation, make sure there are sufficient openings for air to flow freely through the amplifier.

7.3 Connection cables

To connect the amplifier to the speakers, always use suitable cables to avoid amplifier power dispersion due to inadequate cable section. When connecting the amplifier to the mixer, only use shielded cables and not electric power cables. The main inputs and outputs are connected using *Cannon® XLR* and *Neutrik® SpeakOn* connectors.

7.4 Configurations



| XLR BAL INPUT/OUTPUT | |
|----------------------|--------|
| Pin 1 | GND |
| Pin 2 | HOT + |
| Pin 3 | COLD - |

| Neutrik® speakON | |
|------------------|---------------|
| Pin 1 + | POS (CH1 CH3) |
| Pin 1 - | NEG (CH1 CH3) |
| Pin 2 + | POS (CH2 CH4) |
| Pin 2 - | NEG (CH2 CH4) |

Figure 9. Cannon® XLR and Neutrik® SpeakOn connectors

Make sure the unit is switched off before configuring according to your requirements. To turn on the unit, use the ON/OFF switch located on the right of the front panel. To adjust the volume of individual channels turn the corresponding knobs, i.e. ChA/ChB for PS1000, PS1400, PS2000, PS2600 and PS3400 and ChA/ChB/ChC/ChD for PS650-F.

With audio systems it is always better to *switch off the amplifier first*. Remember to switch off the amplifier before connecting or disconnecting it to other units and always switch on the mixer first and then the amplifier, in order to avoid peaks that could cause disturbances and may damage the speakers.

• Using in stereo mode (standard)

When using in stereo mode, each channel operates independently and the dedicated input attenuators control the respective channel level. The recommended minimum load for using in stereo mode is **4 Ω per channel** for all Peecker Sound **Professional Series** models (see *Technical Specifications*). To connect the input signal, use the Cannon XLR connectors on the rear panel. The loudspeaker systems must be connected to the *Neutrik® SpeakOn* output connectors.

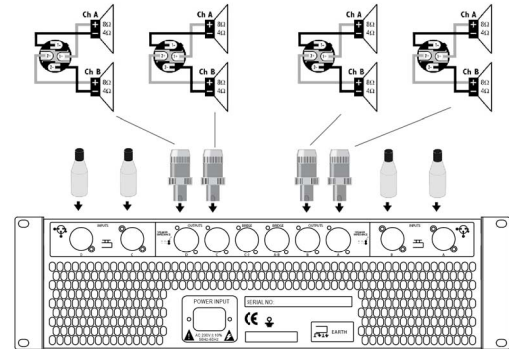

Figure 10. Stereo Mode PS650-F

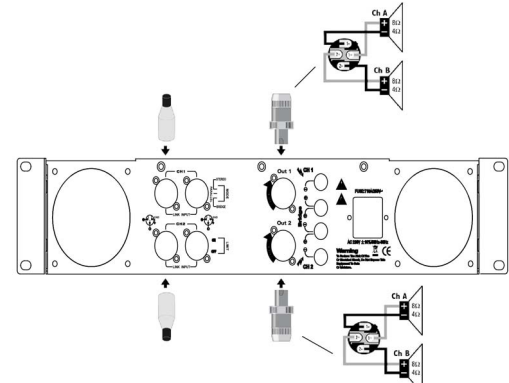

Figure 11. Stereo Mode PS1000

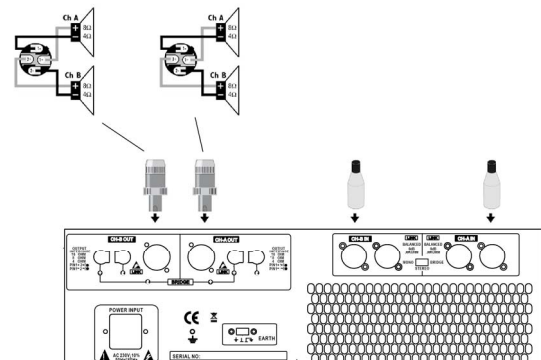

Figure 12. Stereo Mode PS1400

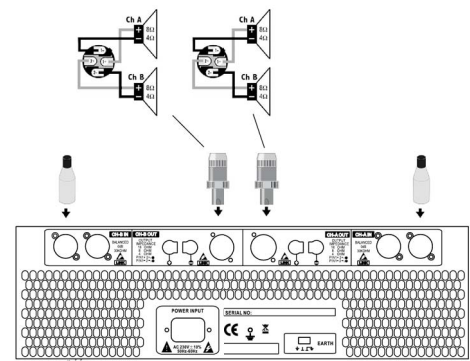
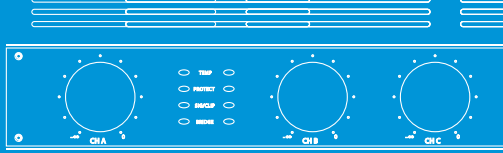

Figure 13. Stereo Mode PS2000 - PS2600 - PS3400



• Using in mono bridge mode

To activate the *mono bridge* mode, set the switches on the rear panel on the *Bridge* position. This configuration is only available in *PS650-F*, *PS1000* and *PS1400* models. Using in mono bridge mode requires both amplifier channels (A and B, C and D) to operate with the same input signal but with inverted phases. Power values can be found in the technical specifications table at the end of this manual.

To use the *PS650-F* model in mono bridge mode, the input signal necessarily has to be connected to Ch A (for bridging between Ch A and Ch B) and to Ch C (for bridging between Ch C and Ch D). The corresponding volume is adjusted using the potentiometers of Ch A and Ch C. Make sure that the level attenuators are in the same position.

In the case of *PS1000*, the input signal necessarily has to be connected to Ch A and the corresponding volume is thus adjusted using the potentiometer of Ch A.

The input signal for *PS1400*, on the other hand, must necessarily be connected to Ch A and the corresponding volume is thus adjusted by the potentiometer of Ch A. To connect the input signal, use the Cannon® XLR connectors on the rear panel. The speakers must be connected to the Neutrik® SpeakOn output connectors.



Note: when using in bridge mode do not connect loads under 8 Ω.

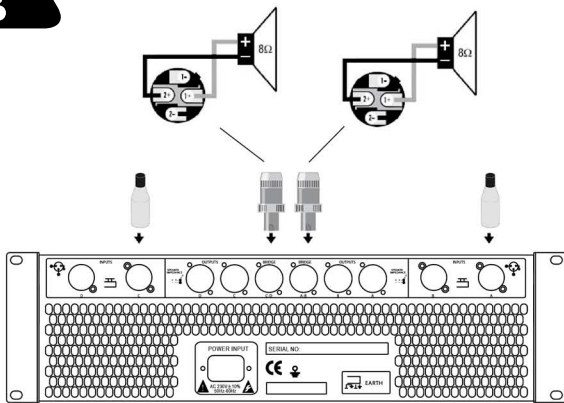

Figure 14. Bridge Mode PS650-F

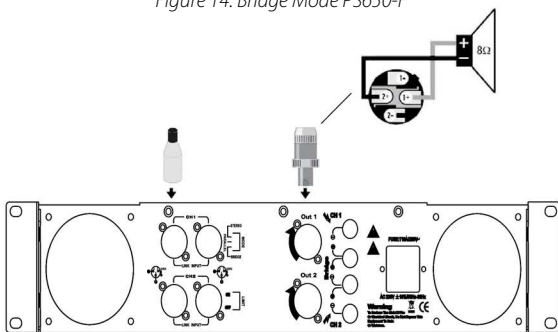

Figure 15. Bridge Mode PS1000

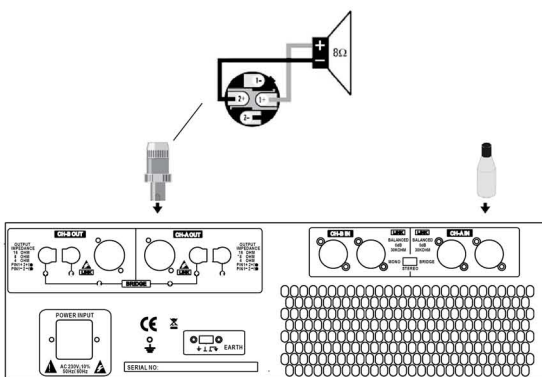

Figure 16. Bridge Mode PS1400

• Parallel inputs

Parallel mode is activated using the dedicated switches on the rear panel. When operating in parallel mode, the inputs of both channels are connected and receive the same signal.

This function is only available in models *PS1000* and *PS1400*. To connect the input signal, use Cannon® XLR connectors.

The loudspeaker systems must be connected to the Neutrik® SpeakOn output connectors.



Make sure that only the inputs are connected in parallel. Never earth positive output terminals or connect them in parallel.

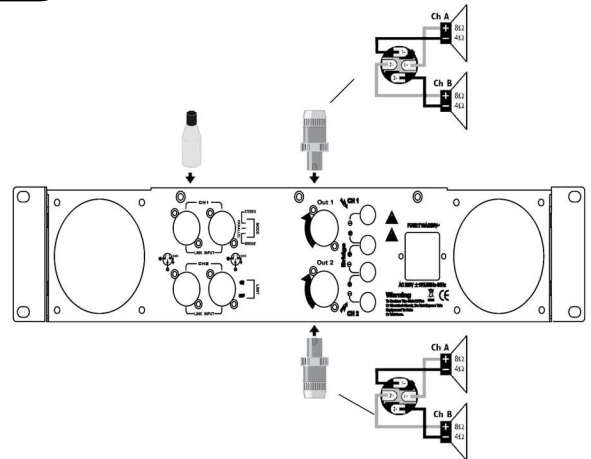

Figure 17. Parallel Mode PS1000

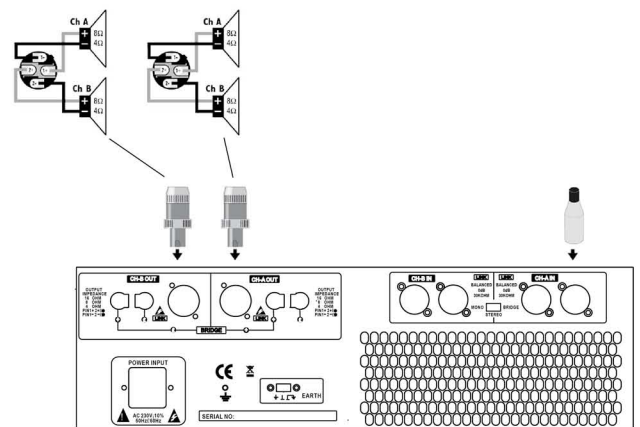
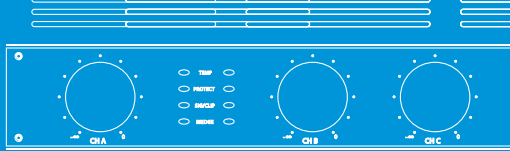

Figure 18. Parallel Mode PS1400



8. PROTECTION SYSTEM FEATURES

All Peecker Sound **Professional Series** amplifiers are equipped with powerful systems to protect the amplifier and its load. Protection systems are designed to ensure that power amplifiers have a long operating life.

8.1 Limiter

When the CLIP LED lights up, the limiter is active. In this case the channel gain will be reduced automatically to protect the load (acoustic speakers) from damage caused by a distorted signal. The limiter circuit cannot be deactivated, except for the PS1000 amplifier.

8.2 Thermal protection

The temperature level of the heat sink is constantly monitored, as indicated by the TEMP LED. When the heat sink temperature goes above 60° C the cooling fan switches on, while at 90° C (anomalous operating condition) the TEMP LED lights up and the whole system goes into *mute mode* until the temperature returns to normal levels.

8.3 Load safety control

The state of the input signal in Peecker Sound amplifiers is constantly monitored. Should the power load exceed the maximum allowable level, the output voltage will be automatically readjusted so that the amplifier can operate safely. Should the connected load impedance be significantly below recommended levels, the amplifier output phase will be inhibited.

8.4 DC Protection

The presence of a DC voltage is monitored on both channels independently. If a value equal to or above 7 Volts is detected, the amplifier output stage will be inhibited. This protects the speakers against DC voltage.

8.5 Power on/off transients

To eliminate power on/off transients, which can damage the loudspeaker systems, a soft start circuit is enabled that connects the load with delay and disconnects it immediately.

9. TESTING PROCEDURE FOR ELECTRO-MECHANICAL OPERATION

The testing protocols for the various series of amplifiers manufactured by Sound Corporation (XTDT series by X-Treme and PSDSP and **PS series** by **Peecker Sound**) have been designed according to the *FMEA (Failure Mode and Effect Analysis)* method.

This is a risk assessment system deriving from electro-mechanical reliability studies used widely in industrial and non-industrial sectors to evaluate the reliability of both products and processes. FMEA consists of procedures for analysing potential failures; they are repeatable, transparent and guarantee total control of the operating functions and absolute reliability of the manufactured products.

FMEA results basically consist of the following two documents:

- The first is an internal Sound Corporation tool designed for the Product Development Department with an indication of the various critical areas detected and suggested actions for improvement, such as increasing *MTTF (Mean Time to Failure)* and/or the life cycle of the amplifier under investigation.
- The second arises from detailed knowledge of failure modes and is used to determine precisely the amplifier correct operating conditions as well as the corresponding checking operations.

This procedure is also available to the final customer in the form of checking procedure for the amplifier correct electro-mechanical operation, as provided below.



Note: Before removing any module or connector, remember to disconnect the amplifier from the mains and take care when handling power supply capacitors as they might be under load.

To prevent short-circuits during testing, the oscilloscope must be earth insulated. Do not test the amplifier while the speakers or cones are output connected, use the appropriate dummy loads only. When increasing the output voltage of the variable voltage transformer (Variac), never exceed the amplifier nominal output value plus its tolerance, since higher voltage levels might seriously damage the amplifier.

9.1 Required equipment

List of testing equipment:

- Digital multimeter
- AC millivoltmeter
- Dual trace oscilloscope
- Audio signal generator
- 15A-250V Variac
- Two 4 Ω (1800W) dummy loads
- Two 8 Ω (1100W) dummy loads
- *Audio Precision* (AP) analyser
- Vibrating table for mechanical testing
- Withstanding voltage tester

9.2 Visual check

Check that the product is correctly assembled and verify whether there are any incorrectly mounted or damaged parts, open connections or short circuits.

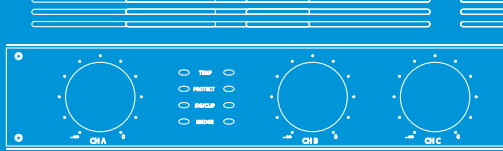

9.3 Electrical testing procedures

1. Use the *withstanding voltage tester* to test the amplifier: turn off the amplifier, set the voltage testing level at 1500 V and the test time at 60 seconds. If the leakage current does not go above 5 mA the test has been successful.
2. Check the whole unit thoroughly for any *short circuits* using the multimeter. Verify that the voltage supply and earthing are correct and that the power supply cable is undamaged. After the amplifier has been turned on once, make sure there are no short circuits.
3. Using the Variac, set the *power supply* in the primary coil of the transformer at 230 V. This voltage value has to be monitored and adjusted in order to be kept constant throughout the duration of the test. Turn the amplifier on and off six times to check whether the power switch works correctly, the relays are activated (with a certain amount of delay), and both protection LEDs are flashing.
4. Check that the *voltages* in the power supply module are as follows:
 - PS650-F:
 - A) AC voltage values in the secondary coil should be: 65V---0---65V, 20V---0---20V, 17V---0---17V, 0---10V.
 - B) DC voltage on the amplifier modules should be ± 89 V. (tolerance: ± 1 V).
 - C) Protection circuits power supply voltage: ± 24 V. (tolerance ± 2 V).
 - D) Fans power supply voltage: -24V (tolerance ± 2 V).
 - E) Power supply voltage in the pre-amplifier module: ± 12 V (tolerance $\leq \pm 0.5$ V).
 - PS1000:
 - A) AC voltage values in the secondary coil should be: 56V---0---56V (GRN---BLK---BLU).
 - B) DC voltage on the amplifier module should be ± 77 V.
 - C) Fans' power supply voltage: +24 V.
 - PS1400:
 - A) AC voltage values in the secondary coil should be: 65V---0---65V (GRN---BLK---GRN), 19V---0---19V (BLU---BLK---BLU), 17V---0---17V (YEL---BLK---YEL), 0---10V (WHI---WHI).
 - B) DC voltage on the amplifier module should be ± 88 V.
 - C) Fans' power supply voltage: +24 V.
 - PS2000-PS2600-PS3400
 - A) AC voltage values in the secondary coil should be: 56V---0---56V (PS3400), 50V---0---50V (PS2600), 45V---0---45V (PS2000). All models must have the following AC output voltage values: 19V---0---19V, 17---0---17V, 0---10V.
 - B) DC voltage on the amplifier modules should be: ± 78 V (PS3400), ± 68 V (PS2600), ± 61 V (PS2000) (tolerance: ± 1 V).
 - C) Protection circuits power supply voltage: ± 24 V (tolerance ± 2 V).
 - D) Fans power supply voltage: +24 V.
 - E) Power supply voltage in the pre-amplifier module: ± 12 V. (tolerance $\leq \pm 0.5$ V).
5. Check that the *background noise* in both channels is below 1 mV (-58 dBu) and that there is no signal after switching off the unit. Use the oscilloscope to perform this test, connecting a speaker for a sound check if necessary.
 - 5.a. (Only applicable to PS2000 – PS2600 – PS3400)

Measure the voltage on collectors for Q104, Q103, Q204 and Q203 and check that it is ± 1.2 V. If necessary, adjust the 1 k Ω trimmer so that this value has a tolerance level less than or equal to ± 0.1 V ($\leq \pm 0.1$ V). The output terminal DC voltage must be less than or equal to 10 mV (≤ 10 mV).
6. *Dynamic testing*:
 - Set a sinusoidal signal at 1 kHz (set the signal level at a value close to clip LED activating signal).
 - Connect a 4 Ω load (of suitable power) in one channel only. The output signal voltage should be: 57 V (PS650-F), 47 V (PS1000), 56 V (PS1400), 72 V (PS2000), 82 V (PS2600), 92 V (PS3600).
 - Check that the output waveform is regular. Shake the input/output connectors to check that they are reliable and there are no faulty contacts.
7. *Signal LED test*: check that the LED lights up when there is an input signal (set the Gain of each channel at maximum level).
8. Make sure that the *crosstalk* is greater than or equal to 50 dB (≤ 50 dB).
9. Check that the *CMRR* (@ 1kHz) is greater than or equal to 60 dB (≤ 60 dB).
10. Check the *phase* between output and input.
11. Connect the 8 Ω loads on both channels, set the volume to maximum level and check that there is *no background noise* due to the power supply transformer.
12. Test the *frequency response*: 20 Hz-20 kHz ± 0.5 dB.
13. Bring the heat sink temperature to 50° C (PS650-F, PS1400, PS2000, PS2600, PS3400) or 70° C (PS1000) and check that the *fans* are operating (and noiseless).
14. Check that, at maximum output power, the *current* is:
 - PS650-F: 6 A with an 8 Ω load; 10 A with a 4 Ω load
 - PS1000: 6 A with an 8 Ω load; 10 A with a 4 Ω load
 - PS1400: 7 A with an 8 Ω load; 13 A with a 4 Ω load
 - PS2000: 9 A with an 8 Ω load; 15 A with a 4 Ω load
 - PS2600: 10 A with an 8 Ω load; 18 A with a 4 Ω load
 - PS3400: 11 A with an 8 Ω load; 20.5 A with a 4 Ω load
15. *Output protection test*: short-circuit the output with 0 Ω and check that the protection system activates (the relays should disconnect the load).
16. Adjust the *mains power supply voltage* (using the *Variac*) from 205 V to 255 V and check that the amplifier is operating correctly.
17. Check that the *THD* (@ 1kHz) is less than or equal to 0.08% with an 8 Ω load.
18. Test for *vibrations* and correct amplifier operation using the vibrating table for mechanical tests:
 - Vibration frequency: 5-60 Hz
 - Direction: vertical, horizontal
 - Test duration: 180 seconds
 - Check that there is no output signal after the vibration test has been performed.
19. *Burn-in test*
 - Using a Pink Noise generator, set the input signal so as to obtain 1/8 of nominal output power @ 4 Ω .
 - Check that the Clip LEDs light up occasionally though not too repeatedly.
 - After 4 hours of testing, check general operating functions.

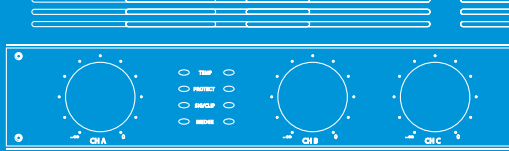

10. TECHNICAL SPECIFICATIONS

| MODEL | PS1000 | PS1400 | PS2000 | PS2600 | PS3400 | PS650-F |
|--|--|----------------|----------------|----------------|----------------|----------------|
| Power Output (per channel) | | | | | | |
| 8 Ω | 280 W* | 450 W* | 650 W* | 850 W* | 1000 W* | 300 W* |
| 4 Ω | 450 W* | 700 W* | 1000 W* | 1300 W* | 1700 W* | 650 W* |
| Bridged Mono Power | | | | | | |
| 8 Ω | 880 W* | 1300 W* | / | / | / | 1200 W* |
| * EIA 1 kHz - 1% THD, both ch.s driven @ 230 VAC | | | | | | |
| Net Weight | 14 kg | 22 kg | 32 kg | 32 kg | 33 kg | 30 kg |
| Frequency Response | 20 Hz ÷ 20 kHz (± 0.5 dB) | | | | | |
| SNR | > 100 dB | | | | | |
| Distortion (THD+N) | < 0.1% (@ 1 kHz) | | | | | |
| Level adjustment (per channel) | -∞ ÷ 0 dB | | | | | |
| Input Impedance | 30 kΩ, electronically balanced | | | | | |
| Input Sensitivity | 0 dBu | | | | | |
| Crosstalk | > 50 dB | | | | | |
| Phase Response | -18° (@ 20 Hz), +25° (@ 20 kHz) | | | | | |
| Damping Factor | > 200 (@ 8 Ω, 1 kHz) | | | | | |
| Input Connectors (per channel) | 3-pin Cannon® XLR | | | | | |
| Output Connectors (per channel) | Neutrik® speakON, screw terminals (except for PS650-F) | | | | | |
| Controls | Front: power switch, ChA/ChB (PS650-F: ChC/ChD) gain potentiometers Rear: mode, limit or ground lift switches | | | | | |
| Led Indicators | Temperature, Protect, Clip, Signal, (PS1400, PS650-F: Bridge) | | | | | |
| Amplifier Protections | overload, full short circuit, thermal, ultrasonic and radio frequency immunity | | | | | |
| Load Protections | soft start, soft clip limiter, DC-fault | | | | | |
| Circuitry | class AB | | | | | |
| Cooling | front to rear air flow, fan speed in function of temperature | | | | | |
| Power Requirements | 230 VAC (± 10%) , 50/60 Hz | | | | | |
| Dimensions (WxHxD) | 483 (19") × 132 (3 RU) × 487 mm (PS100: 483 (19") × 88 (2RU) × 388 mm) | | | | | |
| Approvals | CE EN55103-1 (Emissions), CE EN55103-2 (Immunity), CE EN6065, Class I (Safety) | | | | | |

SOUND REINFORCEMENT

CONTROLLED RADIATION

ACOUSTIC RESEARCH